

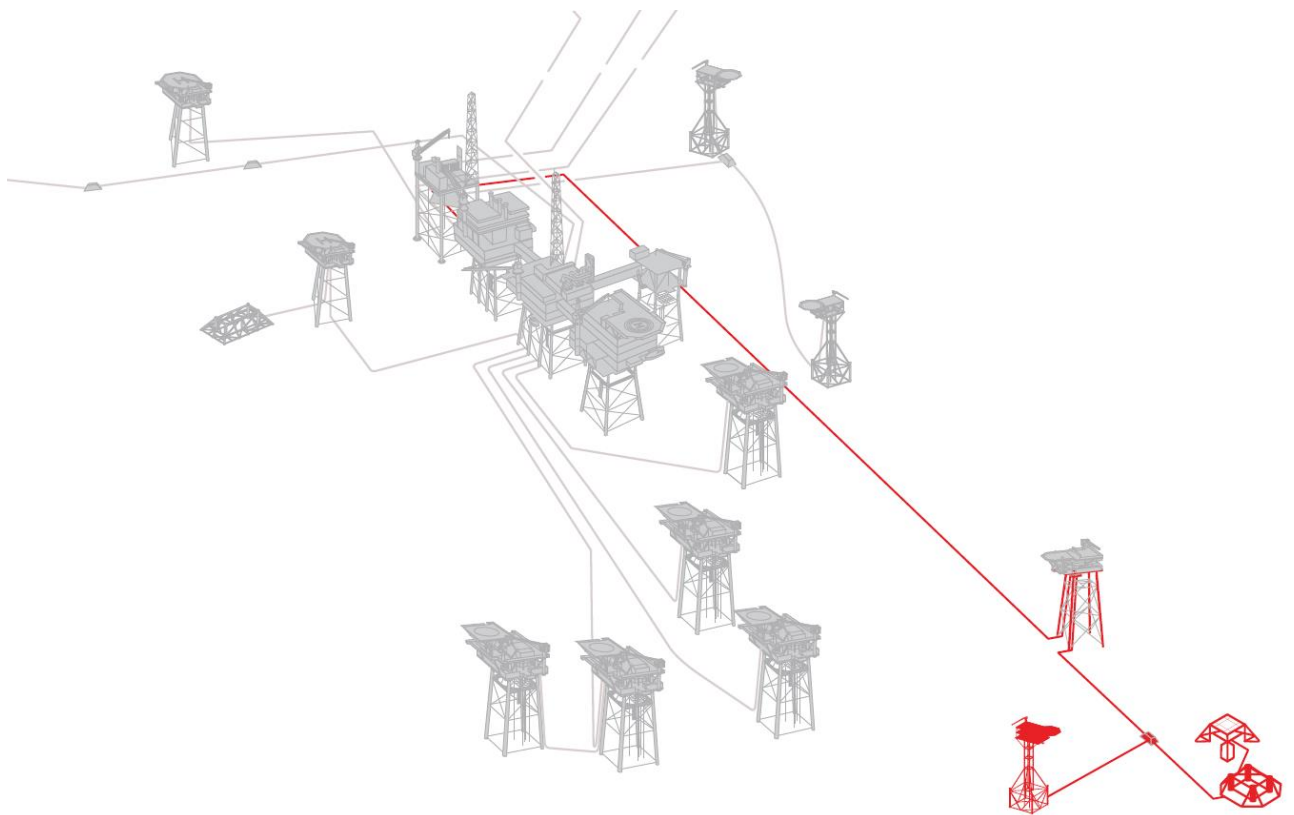

CHRYSAOR



Decommissioning Programmes LOGGS Satellites Jupiter Area

Ganymede ZD Jacket, Europa EZ, Callisto ZM and NW Bell
ZX & Associated Infield Pipelines

FINAL
19 May 2020

DOCUMENT CONTROL

Document Number		COP-SNS-L-XX-X-PM-12-00002	
Document Classification		Public	
Document Ownership		Decommissioning	
Prepared by	C Marston	Date:	27 Jan 2020
Reviewed by	M Burnett	Date:	27 Jan 2020
Approved by	R Tocher	Date:	27 Jan 2020

REVISION RECORD

Revision No	Description of Revision	Date
1	Pre-Draft to OPRED for Review	18 June 2019
2	Updated Draft to OPRED for Review	19 Sept 2019
3	Updated Draft to OPRED for Review	15 Nov 2019
4	Updated Draft for Consultation	21 Jan 2020
5	Updated Draft for Consultation	27 Jan 2020
6	Updated Draft post Consultation	27 March 2020
7	Final Submission	19 May 2020

DISTRIBUTION

Name	Position	Company
R Tocher	Decommissioning Manager	Chrysaor Production (U.K.) Limited
O Dijkstra	Commercial	Equinor UK Limited
L Mathews	UK Joint Interest Projects Advisor	Esso Exploration and Production UK Limited
F Livingston	Senior Decommissioning Manager	OPRED
I Rowe	General Manager	NFFO
S Alexander	Managing Director	SFF
R James	Secretary	NIFPO
J Wrottesley	Permitting Manager	Global Marine Services

Contents

<i>INST = Installations; P/L = Pipelines</i>	INST	P/L
CONTENTS.....	3	
A. TABLE OF TERMS AND ABBREVIATIONS.....	5	✓
B. TABLE OF FIGURES AND TABLES	6	✓
C. TABLE OF APPENDICES	7	✓
1 EXECUTIVE SUMMARY	8	
1.1 <i>Combined Decommissioning Programmes</i>	8	✓
1.2 <i>Requirement for Decommissioning Programmes</i>	8	✓
1.3 <i>Introduction</i>	9	✓
1.4 <i>Overview of Installations and Pipelines Being Decommissioned</i>	10	✓
1.4.1 <i>Installations</i>	10	✓
1.4.2 <i>Pipelines</i>	13	✓
1.5 <i>Summary of Proposed Decommissioning Programmes</i>	15	✓
1.6 <i>Field Location including Field Layout and Adjacent Facilities</i>	19	✓
1.7 <i>Industrial Implications</i>	26	✓
2 DESCRIPTION OF ITEMS TO BE DECOMMISSIONED.....	27	
2.1 <i>Surface Facilities (Topsides and Jackets)</i>	27	✓
2.2 <i>Subsea Installations and Stabilisation Features</i>	29	✓
2.3 <i>Pipelines Including Stabilisation Features</i>	31	✓
2.4 <i>Wells</i>	43	✓
2.5 <i>Drill Cuttings</i>	44	✓
2.6 <i>Inventory Estimates</i>	44	✓
3 REMOVAL AND DISPOSAL METHODS.....	46	
3.1 <i>Topsides</i>	46	✓
3.1.1 <i>Topsides Descriptions</i>	46	✓
3.1.2 <i>Topsides Removal Methods</i>	48	✓
3.2 <i>Jackets</i>	49	✓
3.2.1 <i>Jacket Decommissioning Overview</i>	49	✓
3.2.2 <i>Jacket Removal Methods</i>	51	✓
3.3 <i>Subsea Installations and Stabilisation Features</i>	52	✓
3.4 <i>Pipelines</i>	53	✓
3.4.1 <i>Comparative Assessment Method</i>	53	✓
3.4.2 <i>Pipeline Decommissioning Options</i>	56	✓
3.5 <i>Pipeline Stabilisation Features</i>	61	✓
3.6 <i>Wells</i>	66	✓
3.7 <i>Drill Cuttings</i>	66	✓
3.7.1 <i>Drill Cuttings Decommissioning Options</i>	66	✓
3.8 <i>Waste Streams</i>	67	✓
4 ENVIRONMENTAL APPRAISAL OVERVIEW	69	
4.1 <i>Environmental Sensitivities (Summary)</i>	69	✓
4.2 <i>Potential Environmental Impacts and their Management</i>	73	✓
4.2.1 <i>Environmental Impact Assessment Summary</i>	73	✓
5 INTERESTED PARTY CONSULTATIONS.....	78	✓
6 PROGRAMME MANAGEMENT	79	
6.1 <i>Project Management and Verification</i>	79	✓
6.2 <i>Post-Decommissioning Debris Clearance and Verification</i>	79	✓
6.3 <i>Schedule</i>	80	✓
6.4 <i>Costs</i>	81	✓
6.5 <i>Close Out</i>	81	✓
6.6 <i>Post Decommissioning Monitoring and Evaluation</i>	81	✓
7 SUPPORTING DOCUMENTS	82	✓
8 PARTNER LETTERS OF SUPPORT	83	✓

<i>INST = Installations; P/L = Pipelines</i>		INST	P/L
9	APPENDIX 1 – PIPELINE BURIAL DATA..... 84		✓
10	APPENDIX 2 – PUBLIC NOTICES 94	✓	✓
11	APPENDIX 3 – CONSULTEE RESPONSES..... 95	✓	✓

A. Table of Terms and Abbreviations

Abbreviation	Explanation
CA	Comparative Assessment
CSV	Construction Support Vessel
BEIS	Department for Business, Energy and Industrial Strategy
EIA	Environmental Impact Assessment
EMS	Environmental Management System
ES	Environmental Statement
ESDV	Emergency Shutdown Valve
EZ	Europa EZ Satellite Platform
FPAL	First Point Assessment Limited (UK)
HLV	Heavy Lift Vessel
ICES	International Council for the Exploration of the Sea
kg	kilogram
km	kilometre
KP	Kilometre Point
KPI	Key Performance Indicator
LAT	Lowest Astronomical Tide
LDPE	Low Density Polyethylene
LOGGS	Lincolnshire Offshore Gas Gathering System
m	meters
MAT	Master Application Template
MCZ	Marine Conservation Zone
MeOH	Methanol
NORM	Naturally Occurring Radioactive Material
NUI	Normally Unattended Installation
OGA	Oil and Gas Authority
OGUK	Oil and Gas United Kingdom
OPRED	Offshore Petroleum Regulator for Environment and Decommissioning
OSPAR	Convention for the Protection of the Marine Environment of the North-East Atlantic
P&A	Plug and Abandon
PMT	Project Management Team
PA	LOGGS PA Accommodation Platform
PC	LOGGS PC Compression Platform
PP	LOGGS PP Processing Platform
PD	North Valiant PD Platform, bridge linked to LOGGS PP Processing Platform
PR	LOGGS PR Platform
PWA	Pipeline Works Authorisation
R2S	Return to Scene
RBA	Risk Based Assessment
SAC	Special Areas of Conservation
cSAC	Candidate Special Areas of Conservation
SAT	Subsidiary Application Template
SLV	Shear Leg Vessel
SNS	Southern North Sea
SPA	Special Protection Areas
Te	Tonne
TGT	Theddlethorpe Gas Terminal
Tscf	Trillion standard cubic foot
UKCS	United Kingdom Continental Shelf
ZD	Ganymede ZD Platform
ZM	Callisto Subsea Tieback
ZX	NW Bell Subsea Tieback

B. Table of Figures and Tables

Figure No	Description	Page
1.1	Jupiter Field Location in UKCS	19
1.2	Jupiter Development Layout	20
1.3	Adjacent Facilities in relation to Oil & Gas Infrastructure	24
1.4	Adjacent Facilities in Relation to Other Non Oil & Gas Features	25
2.1.1	Photograph of Ganymede ZD Jacket	28
2.1.2	Photograph of Europa EZ	28
2.2.1	Photograph of subsea Xmas tree, Callisto ZM	30
2.2.2	Photograph of subsea Xmas tree, NW Bell ZX	30
2.3.1	Schematic showing the layout of the Sinope subsea tee and pigging skid	34
2.3.2	Schematic of Sinope Pigging Skid	35
2.3.3	Photograph of Sinope Tee	36
3.1.1	EZ Topsides Elevation	46
3.2.1	ZD Jacket	49
3.2.2	EZ Jacket	50
6.1	Gantt Chart of Project Plan	80
Table No	Description	Page
1.1a	Installations Being Decommissioned - Ganymede	10
1.1b	Installations Being Decommissioned - Europa	11
1.1c	Installations Being Decommissioned - Callisto	11
1.1d	Installations Being Decommissioned – NW Bell	12
1.2a	Installation Section 29 Notice Holder Details - Ganymede	12
1.2b	Installation Section 29 Notice Holder Details - Europa	12
1.2c	Installation Section 29 Notice Holder Details – Callisto	13
1.2d	Installation Section 29 Notice Holder Details – NW Bell	13
1.3a	Pipelines Being Decommissioned - Ganymede	13
1.3b	Pipelines Being Decommissioned - Europa	13
1.3c	Pipelines Being Decommissioned - Callisto	13
1.3d	Pipelines Being Decommissioned – NW Bell	13
1.4a	Pipelines Section 29 Notice Holder Details - Ganymede	14
1.4b	Pipelines Section 29 Notice Holder Details - Europa	14
1.4c	Pipelines Section 29 Notice Holder Details - Callisto	14
1.4d	Pipelines Section 29 Notice Holder Details – NW Bell	14
1.5	Summary of Decommissioning Programmes	15
1.6	List of Adjacent Facilities	21
2.1	Surface Facilities Information	27
2.2	Subsea Installation and Stabilisation Features	29
2.3	Pipeline / Flowline / Umbilical Information	31
2.4	Subsea Pipeline Stabilisation Features	37
2.5	Well Information	43
2.6	Drill Cuttings Pile Information	44
2.7	Current Installation Material Functional Category Summary	44
2.8	Pipeline and Mattress Material Functional Category Summary	45
3.1	Cleaning of Topsides for Removal	47
3.2	Topsides Removal Methods	48
3.3	Jacket Removal Methods	51
3.4	Subsea Installations and Stabilisation Features	52
3.5	Pipeline or Pipeline Groups / Decommissioning Options	56
3.6	Outcomes of Comparative Assessment	57
3.7	Pipeline Stabilisation Features	61

Table No	Description	Page
3.8	Well Plug and Abandonment	66
3.9	Waste Stream Management Methods	67
3.10	Inventory Disposition	68
4.1	Environmental Sensitivities	69
4.2	Environmental Impact Management	73
5.1	Summary of Stakeholder Comments	78
6.1	Provisional Decommissioning Programme Costs	81
7.1	Supporting Documents	82

C. Table of Appendices

Appendix No	Description
1	Pipeline Burial Depth Information
2	Public Notices
3	Consultee Responses

1 Executive Summary

1.1 Combined Decommissioning Programmes

The Jupiter field was developed in two phases to support the production from the Jupiter area using the LOGGS Gathering Station to transport the produced oil and gas from the field to TGT for further processing and sale. The first phase was the development of the Ganymede ZD NUI platform and Callisto subsea tie-back to Ganymede in 1995. The second phase was the development of the Europa EZ NUI platform and NW Bell ZX subsea tie-back to Callisto ZM in 2000. Decline in production led to the cessation of production that was approved by OGA in 2016, enabling decommissioning activities to commence on the facilities in 2017. The platforms are in cold suspension, awaiting removal and disposal. A separate Ganymede ZD Topside (LDP3b) decommissioning programme was approved on 16 April 2020. The Ganymede ZD jacket remains part of this decommissioning programmes workscope.

This document contains eight decommissioning programmes; for two Lincolnshire Offshore Gas Gathering System (LOGGS) Satellite installation jackets, one installation topsides and pipelines and two subsea tiebacks with wellhead protection structures and pipelines:

- (1) Ganymede ZD jacket and Ganymede template (already removed during conductor retrieval operations under marine licence, ML355)
- (2) Ganymede ZD interfield pipelines for the associated notices served under Section 29 of the Petroleum Act 1998
- (3) Europa EZ installation
- (4) Europa EZ interfield pipelines and subsea tee for the associated notices served under Section 29 of the Petroleum Act 1998
- (5) Callisto ZM subsea tieback with manifold and wellhead protection structure
- (6) Callisto ZM interfield pipelines for the associated notices served under Section 29 of the Petroleum Act 1998
- (7) NW Bell ZX subsea tieback with manifold and wellhead protection structure
- (8) NW Bell ZX interfield pipelines for the associated notices served under Section 29 of the Petroleum Act 1998

The Jupiter facilities to be decommissioned consist of:

- 2 Jupiter Surface Installations: Ganymede ZD jacket and Europa EZ topside and jacket
- 1 subsea tee at the intersection of the Europa EZ to Callisto ZM - Ganymede ZD pipelines
- 2 Jupiter subsea tiebacks with wellhead protection structures: Callisto ZM and NW Bell ZX
- The inter-field pipelines

1.2 Requirement for Decommissioning Programmes

Installations:

In accordance with the Petroleum Act 1998, Chrysaor Production (U.K.) Limited as Operator of the Jupiter Fields and on behalf of the Section 29 notice holders (see Table 1.2 and Section 8) is applying to the Offshore Petroleum Regulator for Environment and Decommissioning (OPRED) to obtain approval for decommissioning of the following installations:

- Jupiter installations: Europa EZ topside and jacket, Ganymede ZD jacket and Ganymede template (template removed under marine licence ML355 during conductor retrieval)
- Subsea installations: Callisto ZM and NW Bell ZX

The details of these are in Section 2 of this document.

Pipelines:

In accordance with the Petroleum Act 1998, Chrysaor Production (U.K.) Limited as Operator of the Jupiter Field and on behalf of the Section 29 notice holders (see Table 1.4 and Section 8) is applying to OPRED to obtain approval for decommissioning of the following associated pipelines:

- Ganymede ZD, Europa EZ, Callisto ZM, NW Bell ZX
- Europa EZ subsea tee at the intersection of the Europa EZ to Callisto ZM - Ganymede ZD pipelines

The details of these are in Section 2 of this document.

In conjunction with public, stakeholder and regulatory consultation, the decommissioning programmes are submitted in compliance with national and international regulations and with consideration of OPRED guidelines. The schedule outlined in this document is for a decommissioning project which commenced with the well plugging and abandonment in 2016 and will span up to 10 years till completion.

1.3 Introduction

The Jupiter Fields were discovered in 1972 by the 49/16-4 well which encountered 325 ft of gas column in the Rotliegendes Group Lemn Sandstone Formation in what became the Ganymede Field. The exploration and appraisal programme continued through the 1990s with discoveries in the Europa, Callisto and Sinope Fields.

The Jupiter Fields were developed in two phases. The strategy of phase 1 was to develop the fields that had been adequately appraised, including flexibility in the initial facilities design to accommodate future development. For phase 1, the development was based on a ten-slot platform at Ganymede located in block 49/22 with Callisto developed from a subsea template and tied back to the Ganymede platform.

Further appraisal of the Europa and Sinope Fields took place in 1994 and the second phase of development was approved in 1998. Phase 2 was developed through a platform located 1km SW of the 49/22-8 Sinope exploration well, called Europa EZ, with a 12" tie-in to the pipeline between the Callisto subsea development and the Ganymede platform and a subsea tie-back. One of the development wells drilled from Europa EZ was an extended reach well, 49/22-N03, into the Sinope North area. The NW Bell well was also drilled from Europa EZ platform via an extended reach well, with a tieback to the Callisto ZM subsea manifold.

The Jupiter Fields consist of several separate gas accumulations which lie within blocks 49/16a, 49/17a, 49/22a, 49/22c, 49/22d and 49/23a (licences P.025 and P.033) in the Southern North Sea of the UKCS. The Ganymede field is located approximately 132km east of the TGT terminal.

The installations covered by this document are in the following Quad/blocks:

- | | |
|----------------------|-------|
| • Ganymede ZD jacket | 49/22 |
| • Europa EZ | 49/22 |
| • Callisto ZM | 49/22 |
| • NW Bell ZX | 49/22 |

First production from the Ganymede Field and Callisto Field was in September 1995. In 2000, NW Bell and Europa came online. This backed out Ganymede and some wells were shut in. When NW Bell and Europa declined in 2001, the Ganymede wells were reinstated.

Production from the Ganymede platform was routed to the existing LOGGS complex via a new 18" pipeline and then commingled with other LOGGS gas and transported to TGT via the existing 36" trunkline. A 12" line connected the Callisto subsea development to Ganymede.

Production from Europa EZ was tied back to the pipeline between the Callisto subsea development and the Ganymede platform.

The Jupiter Field was net cash flow negative in 2014 which initiated decommissioning activities on the Jupiter installations to commence and production to cease from the Jupiter Field in November 2016. In 2017, the Ganymede ZD and Europa EZ unmanned platforms were put into cold suspension, having had their wells plugged and abandoned and the topsides cleaned of hydrocarbons.

The Jupiter satellites Ganymede ZD jacket, Europa EZ and subsea tiebacks Callisto ZM and NW Bell ZX, covered by these Decommissioning Programmes, produced 494 Bscf of gas up to the termination of production in 2016.

Cessation of Production applications were submitted and approved as follows:

Installation	Submission Date	Approval Date
Jupiter (Ganymede, Callisto, Europa, Sinope Fields)	May 2016	June 2016

The Ganymede jacket and Europa platform are small installations with a jacket weight for Ganymede ZD of 1,589Te and a total combined Topsides and Jacket weight of 1,410Te for Europa EZ platform. The Ganymede and Europa Satellites stand in 33.5m (Ganymede) to 35m (Europa) of water. The small size, shallow water depth and design life of the Jupiter Satellites, subsea tiebacks, and associated pipelines has determined the philosophy of their decommissioning, which will be to:

- Well Plug and Abandon (P&A)
- Remove the satellites and subsea tiebacks
- Leave the cleaned pipelines in situ

The other installations and pipelines in the LOGGS Area will be decommissioned at an appropriate time and covered by their own Decommissioning Programmes.

1.4 Overview of Installations and Pipelines Being Decommissioned

1.4.1 Installations

Table 1.1a Installations Being Decommissioned - Ganymede			
Field Names		Quad / Block	
Fields	Ganymede	Production Type	Gas / Condensate
Water Depth	33.5m (Ganymede)	UKCS block	Quad 49 Blocks 22a

Surface Installations			
Number	Type	Topsides Weight (Te)	Jacket Weight (Te)
1	Fixed steel jacket only	N/A	1589

Subsea Installations		Number of Wells	
Number	Type	Number	Type
1	Template (already removed)	8	Platform

Drill Cuttings Piles		Distance to Netherlands Median	Distance from nearest UK coastline
Number of Piles	Total Est volume m ³	km	km
0	0	Ganymede ZD 54km	Ganymede ZD 73km

Table 1.1b Installations Being Decommissioned – Europa			
Field Names		Quad / Block	
Fields	Europa, Sinope	Production Type	Gas / Condensate
Water Depth	35m (Europa), 36m (Sinope Tee)	UKCS block	Quad 49 Blocks 22a, 22c and 22d

Surface Installations			
Number	Type	Topsides Weight (Te)	Jacket Weight (Te)
1	Fixed steel jacket	318	1092

Subsea Installations		Number of Wells	
Number	Type	Number	Type
0	-	6	Platform

Drill Cuttings Piles		Distance to Netherlands Median	Distance from nearest UK coastline
Number of Piles	Total Est volume m ³	km	km
0	0	Europa EZ 51km	Europa EZ 67km

Table 1.1c Installations Being Decommissioned - Callisto			
Field Names		Quad / Block	
Fields	Callisto	Production Type	Gas / Condensate
Water Depth	21m (Callisto)	UKCS block	Quad 49 Block 22a

Surface Installations			
Number	Type	Topsides Weight (Te)	Jacket Weight (Te)
0	-	-	-

Subsea Installations		Number of Wells	
Number	Type	Number	Type
1	Subsea Manifolds complete with wellhead protection systems	1	Subsea

Drill Cuttings Piles		Distance to Netherlands Median	Distance from nearest UK coastline
Number of Piles	Total Est volume m ³	km	km
0	0	Callisto ZM 45km	Callisto ZM 73km

Table 1.1d Installations Being Decommissioned – NW Bell			
Field Names		Quad / Block	
Fields	Bell	Production Type	Gas / Condensate
Water Depth	21m (NW Bell)	UKCS block	Quad 49 Blocks 22a

Surface Installations			
Number	Type	Topsides Weight (Te)	Jacket Weight (Te)
0	-	-	-

Subsea Installations		Number of Wells	
Number	Type	Number	Type
1	Subsea Manifolds complete with wellhead protection systems	1	Subsea

Drill Cuttings Piles		Distance to Netherlands Median	Distance from nearest UK coastline
Number of Piles	Total Est volume m ³	km	km
0	0	NW Bell 45km	NW Bell 73km

See Figure 1.1 for further details.

Table 1.2a Installation Section 29 Notice Holders Details – Ganymede		
Section 29 Notice Holders	Registration Number	Equity Interest
Chrysaor Production (U.K.) Limited (Operator)	00524868	20%
Equinor UK Limited	01285743	30%
Esso Exploration and Production UK Limited	00207426	50%

Table 1.2b Installation Section 29 Notice Holders Details - Europa		
Section 29 Notice Holders	Registration Number	Equity Interest
Chrysaor Production (U.K.) Limited (Operator)	00524868	20%
Equinor UK Limited	01285743	30%
Esso Exploration and Production UK Limited	00207426	50%

Table 1.2c Installation Section 29 Notice Holders Details - Callisto		
Section 29 Notice Holders	Registration Number	Equity Interest
Chrysaor Production (U.K.) Limited (Operator)	00524868	20%
Equinor UK Limited	01285743	30%
Esso Exploration and Production UK Limited	00207426	50%

Table 1.2d Installation Section 29 Notice Holders Details – NW Bell		
Section 29 Notice Holders	Registration Number	Equity Interest
Chrysaor Production (U.K.) Limited (Operator)	00524868	20%
Equinor UK Limited	01285743	30%
Esso Exploration and Production UK Limited	00207426	50%

1.4.2 Pipelines

Table 1.3a Pipelines Being Decommissioned – Ganymede		
Number of Pipelines	2	See Table 2.3
Subsea tee structures	0	See Table 2.3

Table 1.3b Pipelines Being Decommissioned - Europa		
Number of Pipelines	2	See Table 2.3
Subsea tee structures	1	See Table 2.3

Table 1.3c Pipelines Being Decommissioned - Callisto		
Number of Pipelines	3	See Table 2.3
Subsea tee structures	0	See Table 2.3

Table 1.3d Pipelines Being Decommissioned – NW Bell		
Number of Pipelines	3	See Table 2.3
Subsea tee structures	0	See Table 2.3

Table 1.4a Pipelines Section 29 Notice Holders Details - Ganymede

Section 29 Notice Holders	Registration Number	Equity Interest
Chrysaor Production (U.K.) Limited	00524868	20%
Equinor UK Limited	01285743	30%
Esso Exploration and Production UK Limited	00207426	50%

Table 1.4b Pipelines Section 29 Notice Holders Details - Europa

Section 29 Notice Holders	Registration Number	Equity Interest
Chrysaor Production (U.K.) Limited	00524868	20%
Equinor UK Limited	01285743	30%
Esso Exploration and Production UK Limited	00207426	50%

Table 1.4c Pipelines Section 29 Notice Holders Details - Callisto

Section 29 Notice Holders	Registration Number	Equity Interest
Chrysaor Production (U.K.) Limited	00524868	20%
Equinor UK Limited	01285743	30%
Esso Exploration and Production UK Limited	00207426	50%

Table 1.4d Pipelines Section 29 Notice Holders Details – NW Bell

Section 29 Notice Holders	Registration Number	Equity Interest
Chrysaor Production (U.K.) Limited	00524868	20%
Equinor UK Limited	01285743	30%
Esso Exploration and Production UK Limited	00207426	50%

1.5 Summary of Proposed Decommissioning Programmes

Table 1.5: Summary of Decommissioning Programmes		
Selected Option	Reason for Selection	Proposed Decommissioning Solution
1. Topsides (in respect of Europa EZ)		
Complete removal, dismantlement and reuse/recycling and disposal.	Topsides equipment obsolete and degraded, or recovery no longer economic.	Removed by Heavy Lift Vessel (HLV) transported to appropriate land-based facility for dismantlement, recycling and disposal. Equipment that cannot be re-used will be recycled or disposed of as appropriate.
2. Jackets (in respect of Ganymede ZD and Europa EZ)		
Complete removal (3m below seabed), dismantlement and reuse/recycling and disposal.	Meets OPRED regulatory requirements.	Removed by HLV, transported to appropriate land-based facility for dismantlement, recycling and disposal.
3. Subsea Installations (in respect of Callisto ZM and NW Bell ZX)		
Complete removal (3m below seabed), dismantlement and reuse/recycling and disposal.	Meets OPRED regulatory requirements	Removed by Construction Support Vessel (CSV), transported to appropriate land-based facility for dismantlement, recycling and disposal.
4a. Pipelines, Flowlines and Umbilicals (in respect of Ganymede ZD: PL1093, PL1094)		
Pipelines will be flushed and decommissioned in situ. Concrete mattresses and other pipeline stabilisation structures will be decommissioned in situ.	<p>In situ decommissioning with minimum intervention option:</p> <p>All mattresses would be left in situ to maintain pipeline stabilisation.</p> <p>Minimise disturbance of the established environment.</p> <p>Reduce the requirement for the introduction of new material (Rock Dump) to the North Norfolk Sandbanks and Saturn Reef Special Area of Conservation (SAC).</p>	<p>Pipelines will be flushed of mobile hydrocarbons prior to subsea disconnection from the satellites and the flushing contents will be disposed of into a donor well at the North Valiant PD installation.</p> <p>Pipelines will be left open and flooded with seawater with a maximum of 25T rock dumped on the cut ends as required.</p> <p>Post flushing, the remaining pipeline would be left in its current state, marked on sea charts and notifications issued to fishermen/other users of the sea.</p> <p>Concrete mattresses and other pipeline stabilisation structures will be decommissioned in situ. Mattresses that are moved to gain access to pipelines, will be recovered where safe to do so.</p>

Table 1.5: Summary of Decommissioning Programmes		
Selected Option	Reason for Selection	Proposed Decommissioning Solution
4b. Pipelines, Flowlines and Umbilicals (in respect of Europa EZ: PL1694, PL1695)		
Pipelines will be flushed and decommissioned in situ. Concrete mattresses and other pipeline stabilisation structures will be decommissioned in situ.	<p>In situ decommissioning with minimum intervention option:</p> <p>All mattresses would be left in situ to maintain pipeline stabilisation.</p> <p>Minimise disturbance of the established environment.</p> <p>Reduce the requirement for the introduction of new material (Rock Dump) to the North Norfolk Sandbanks and Saturn Reef Special Area of Conservation (SAC).</p>	<p>Pipelines will be flushed of mobile hydrocarbons prior to subsea disconnection from the satellite and subsea tee structure and the flushing contents will be disposed of into a donor well at the North Valiant PD installation.</p> <p>Pipelines will be left open and flooded with seawater with a maximum of 25Te rock dumped on the cut ends as required.</p> <p>Post flushing, the remaining pipeline would be left in its current state, marked on sea charts and notifications issued to fishermen/other users of the sea.</p> <p>Concrete mattresses and other pipeline stabilisation structures will be decommissioned in situ.</p> <p>Mattresses that are moved to gain access to pipelines, will be recovered where safe to do so.</p>
Subsea tees in respect of Europa EZ: Complete removal (3m below seabed), dismantlement and reuse/recycling and disposal.	Meets OPRED regulatory requirements.	Removed by Construction Support Vessel (CSV), transported to appropriate land-based facility for dismantlement, recycling and disposal.
4c. Pipelines, Flowlines and Umbilicals (in respect of Callisto ZM: PL1091, PL1092, PLU4178)		
PL1091, PL1092		
Pipelines will be flushed and decommissioned in situ. Concrete mattresses and other pipeline stabilisation structures will be decommissioned in situ.	<p>In situ decommissioning with minimum intervention option:</p> <p>All mattresses would be left in situ to maintain pipeline stabilisation.</p> <p>Minimise disturbance of the established environment.</p> <p>Reduce the requirement for the introduction of new material (Rock Dump) to the North Norfolk Sandbanks and Saturn</p>	<p>Pipelines will be flushed of mobile hydrocarbons prior to subsea disconnection from the satellite and subsea manifold and the flushing contents will be disposed of into a donor well at the North Valiant PD installation.</p> <p>Pipelines will be left open and flooded with seawater with a maximum of 25Te rock dumped on the cut ends as required.</p> <p>Post flushing, the remaining pipeline would be left in its current state, marked on sea charts and notifications issued to fishermen/other users of the sea.</p>

Table 1.5: Summary of Decommissioning Programmes		
Selected Option	Reason for Selection	Proposed Decommissioning Solution
	Reef Special Area of Conservation (SAC).	Concrete mattresses and other pipeline stabilisation structures will be decommissioned in situ. Mattresses that are moved to gain access to pipelines, will be recovered where safe to do so.
PLU4178		
Umbilical will be flushed and there will be partial removal of the single mid field non-spanning umbilical exposure. Concrete mattresses and other umbilical stabilisation structures will be decommissioned in situ.	<p>Decommissioning by Partial Removal of exposures:</p> <p>The umbilical is an electric bundle surrounded by hydraulic hoses that are bound by an outer LDPE sheath. Partial removal is recommended to remove the exposure of the thermoplastic material.</p> <p>Exposure is minor and non-spanning. Persistent nature of exposure is likely to lead to permanent removal upon remediation, without the exposure migrating further along the umbilical.</p> <p>The small dimension and flexible nature of the umbilical provides accessibility to the flowline below the seabed without a requirement for significant dredging.</p> <p>Dynamic seabed provides the potential for natural backfill without the use of rock cover to stabilise the cut ends.</p> <p>Minimise disturbance of the established environment by potentially avoiding the</p>	<p>Umbilical will be flushed of mobile hydrocarbons prior to subsea disconnection from the satellite and subsea manifold and the flushing contents will be disposed of into a donor well at the North Valiant PD installation.</p> <p>Umbilical will be left open and flooded with seawater with a maximum of 25Te rock dumped on the cut ends as required.</p> <p>Cut and remove single mid field exposure. Remediation to be undertaken at a sufficient depth to allow natural backfill of the seabed over cut umbilical ends to reduce requirement for rock placement.</p> <p>Post remediation, the remaining umbilical would be left in its current state, marked on sea charts and notifications issued to fishermen/other users of the sea.</p> <p>Concrete mattresses and other umbilical stabilisation structures will be decommissioned in situ.</p> <p>Survey to be undertaken following remediation (timing to be discussed and agreed with OPRED) to confirm the burial status of the cut umbilical ends.</p>

Table 1.5: Summary of Decommissioning Programmes		
Selected Option	Reason for Selection	Proposed Decommissioning Solution
	<p>requirement for rock on the cut umbilical ends.</p> <p>Reduces the requirement for the introduction of new material (Rock Dump) to the North Norfolk Sandbanks and Saturn Reef Special Area of Conservation (SAC).</p>	
Subsea manifold and wellhead: Complete removal (3m below seabed), dismantlement and reuse/recycling and disposal.	Meets OPRED regulatory requirements.	Removed by Construction Support Vessel (CSV), transported to appropriate land-based facility for dismantlement, recycling and disposal.
4d. Pipelines, Flowlines and Umbilicals (in respect of NW Bell ZX: PL1690, PL1691, PLU4177)		
Pipelines and associated stabilisation features will be fully removed.	<p>Full Removal of all pipelines:</p> <p>Pipelines are short in length (80m). They are surface laid and covered by mattresses that are buried by sand.</p> <p>Reduces the requirement for the introduction of new material (Rock Dump) to the North Norfolk Sandbanks and Saturn Reef Special Area of Conservation (SAC).</p>	<p>Pipelines will be flushed of mobile hydrocarbons prior to subsea disconnection from the subsea manifolds and the flushing contents will be disposed of into a donor well at the North Valiant PD installation.</p> <p>Unburial of pipelines and stabilisation features to assist with pipeline removal.</p> <p>Reasonable efforts will be taken to remove and recover all mattresses where safe to do so.</p> <p>Pipeline removal to take place by cut and lift operations.</p> <p>Post removal, a seabed survey and verification of seabed state will be conducted to confirm the removal of snagging risks to fishing operations.</p>
Subsea manifold and wellhead: Complete removal (3m below seabed), dismantlement and reuse/recycling and disposal.	Meets OPRED regulatory requirements.	Removed by Construction Support Vessel (CSV), transported to appropriate land-based facility for dismantlement, recycling and disposal.
5. Well Abandonment Operations (in respect of Ganymede ZD, Europa EZ: including the Sinope well, Callisto ZM, NW Bell ZX)		
Permanent well Plug and Abandonment (P&A).	Meets OGA and HSE regulatory requirements.	Abandonment in accordance with Oil and Gas UK Well Decommissioning Guidelines.

Table 1.5: Summary of Decommissioning Programmes		
Selected Option	Reason for Selection	Proposed Decommissioning Solution
6. Drill Cuttings (in respect of Ganymede ZD, Europa EZ, Callisto ZM, NW Bell ZX)		
None required.	No Drill Cuttings Piles have been identified by seabed survey.	None required.
7. Interdependencies		
Platform and subsea manifold removal can only occur after Well P&A and Topsides / Pipeline cleaning.		

1.6 Field Location including Field Layout and Adjacent Facilities

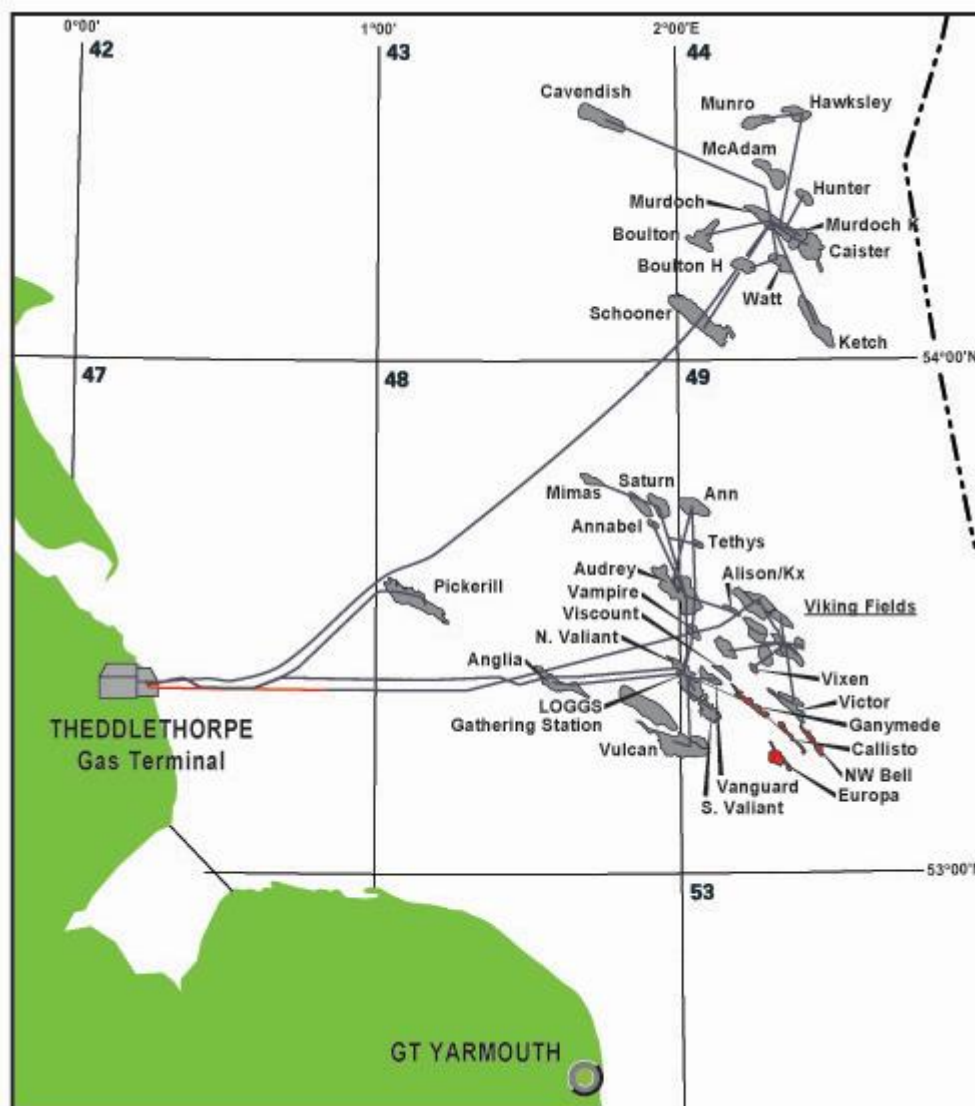

Figure 1.1 – Jupiter Field Location in UKCS

The Jupiter developments are part of the Chrysaor’s Southern North Sea (SNS) Gas Operation with the installations and pipelines covered by these decommissioning programmes highlighted in red in the Field Layout Figure 1.2.

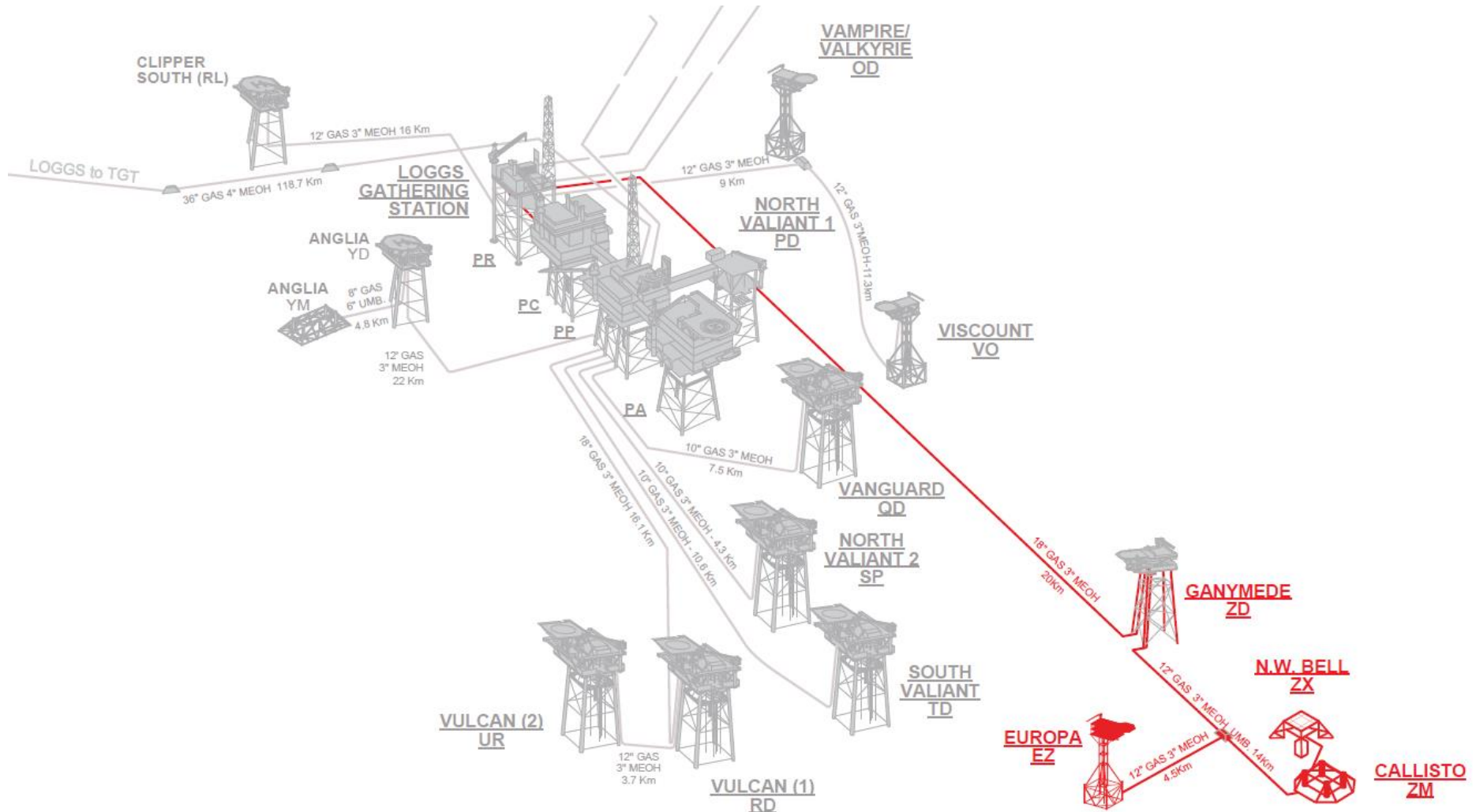

Figure 1.2 – Jupiter Development Layout

Facilities adjacent to the Jupiter facilities that are potentially impacted by these decommissioning programmes are listed below in Table 1.6 and highlighted in red in Figure 1.3.

Table 1.6 List of Adjacent Facilities					
Owner	Name	Type	Distance / Direction	Information	Status
Pipelines					
Chrysaor Production (U.K.) Limited / Chrysaor Petroleum Limited/ BP Exploration (Alpha) Limited / BP Exploration Beta Limited	PL1692	12" Gas Pipeline	Vampire OD to LOGGS PR 9km	Pipeline adjacent to Ganymede ZD PL1093 and PL1094 as it approaches PR	Out of use
Chrysaor Production (U.K.) Limited / Chrysaor Petroleum Limited/ BP Exploration (Alpha) Limited / BP Exploration Beta Limited	PL1693	3" MeOH Pipeline	LOGGS PR to Vampire OD to 9km	Pipeline adjacent to Ganymede ZD PL1093 and PL1094 as it approaches PR	Out of use
Chrysaor Production (U.K.) Limited / Britoil Limited	PL2643	16" Gas Pipeline	Viking BP to LOGGS PR 26.9km	Pipeline adjacent to Ganymede ZD PL1093 and PL1094 as it approaches PR	Out of use
Chrysaor Production (U.K.) Limited / Britoil Limited	PL2644	3" MeOH Pipeline	LOGGS PR to Viking BP 26.9km	Adjacent to Ganymede ZD PL1093 and PL1094 as it approaches PR	Out of use

Table 1.6 List of Adjacent Facilities					
Owner	Name	Type	Distance / Direction	Information	Status
Chrysaor Production (U.K.) Limited / Ineos UK SNS Limited / Spirit North Sea Gas Limited	PL2107	14" Gas Pipeline	Saturn ND to LOGGS PR 43km	Adjacent to Ganymede ZD PL1093 and PL1094 as it approaches PR	Out of use
Chrysaor Production (U.K.) Limited / Ineos UK SNS Limited / Spirit North Sea Gas Limited	PL2108	3" MeOH Pipeline	LOGG PR to Saturn ND 43km	Adjacent to Ganymede ZD PL1093 and PL1094 as it approaches PR	Out of use
Chrysaor Production (U.K.) Limited / Chrysaor Petroleum Limited / BP Exploration (Alpha) Limited / BP Exploration Beta Limited	PL454	36" Gas Pipeline	LOGGS PP to TGT 118.7km	Pipeline crosses Ganymede ZD PL1093 and PL1094 as it approaches PR	Out of use
Chrysaor Production (U.K.) Limited / Chrysaor Petroleum Limited / BP Exploration (Alpha) Limited / BP Exploration Beta Limited	PL455	4" MeOH Pipeline	TGT to LOGGS PP 118.7km	Pipeline crosses Ganymede ZD PL1093 and PL1094 as it approaches PR	Out of use
Third Party Crossings					
Spirit Energy North Sea Limited	PL947	12" Gas Pipeline	Ann to LOGGS PR 42km	Adjacent to Ganymede ZD PL1093 and	Out of use

Table 1.6 List of Adjacent Facilities					
Owner	Name	Type	Distance / Direction	Information	Status
				PL1094 as it approaches PR	
Spirit Energy North Sea Limited	PL496	20" Gas Pipeline	Audrey WD to LOGGS PP 16.8km	Pipeline crosses Ganymede ZD PL1093 and PL1094 as it approaches PR	Out of use
Spirit Energy North Sea Limited	PL497	3" MeOH Pipeline	LOGGS PP to Audrey WD 16.8km	Pipeline crosses Ganymede ZD PL1093 and PL1094 as it approaches PR	Out of use
Surface Installations					
Chrysaor Developments Limited / BP Exploration (Alpha) Limited	North Valiant PD	Unmanned Platform	Ganymede ZD to LOGGS PD 17km	Adjacent to Ganymede ZD – LOGGS PR: PL1093 and PL1094 pipelines	Active
Chrysaor Production (U.K.) Limited / Chrysaor Petroleum Limited / BP Exploration (Alpha) Limited / BP Exploration Beta Limited	LOGGS PR	LOGGS Complex	Ganymede ZD to LOGGS PR 17km	Connected to Ganymede ZD – LOGGS PR: PL1093 and PL1094 pipelines	Active

Impacts of Decommissioning Proposals
No anticipated impact on adjacent facilities if pipelines are decommissioned in situ.

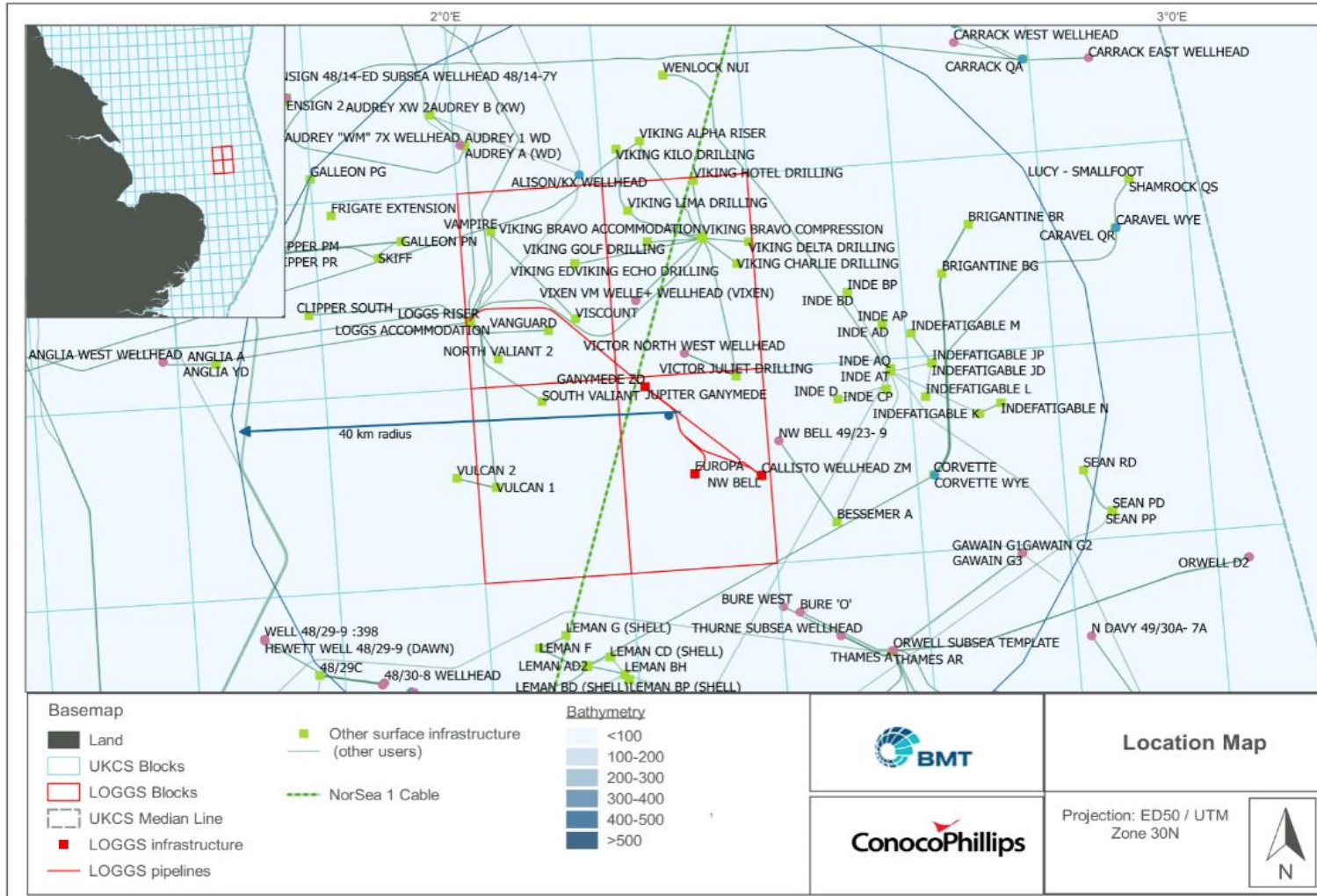

Figure 1.3 – Adjacent Facilities in relation to Oil & Gas Infrastructure (Jupiter infrastructure and pipelines in red)

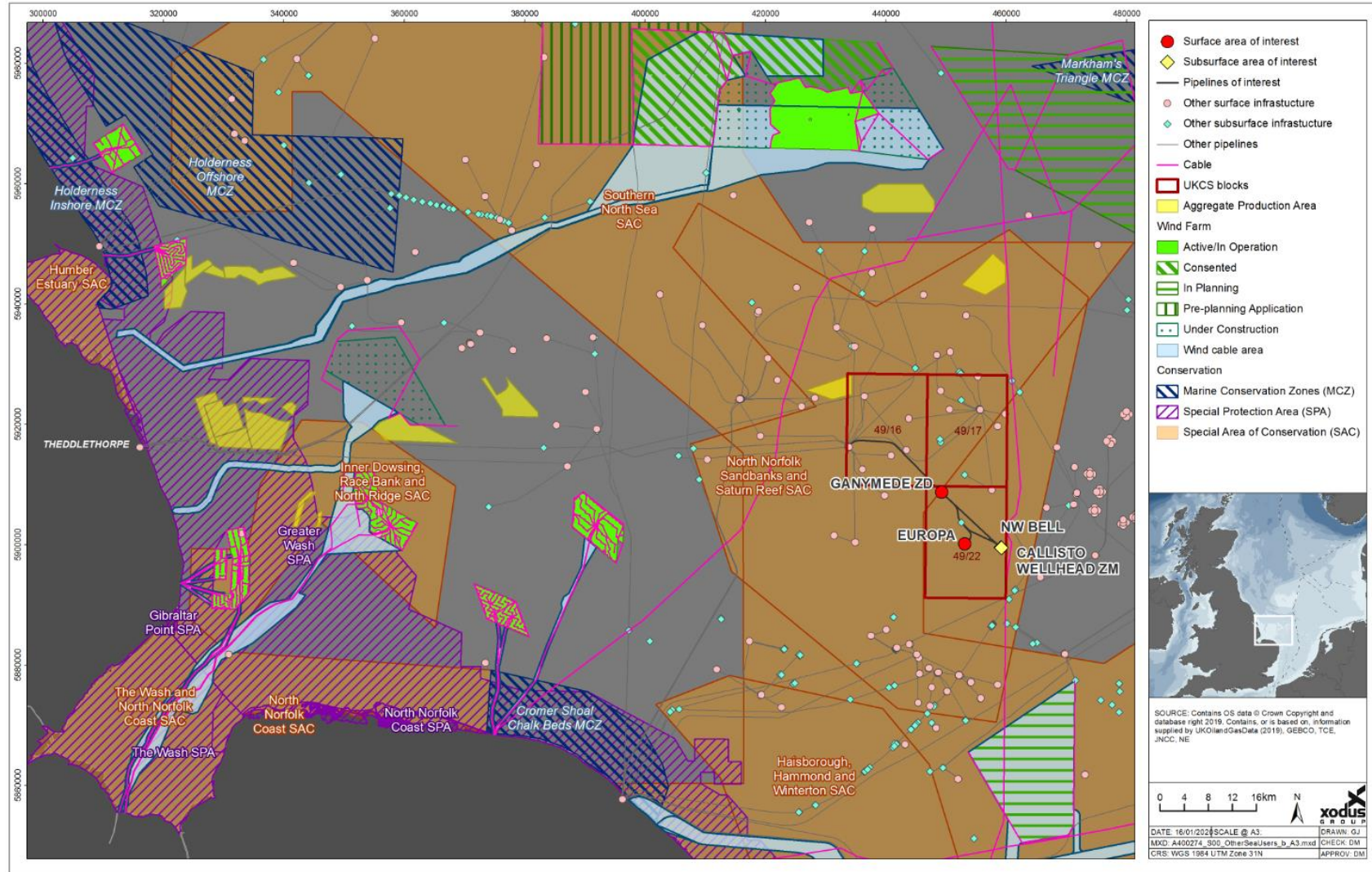

Figure 1.4 – Adjacent Facilities in Relation to Other Non Oil & Gas Features

1.7 Industrial Implications

Principles of the contracting and procurement strategies to be utilised by Chrysaor as operator and on behalf of the other Section 29 notice holders, for the decommissioning of the Jupiter facilities (Ganymede ZD Jacket, Europa EZ Satellite, Callisto ZM subsea manifold, NW Bell subsea manifold) are listed below:

1. Chrysaor participates in the PILOT Share Fair events providing one to one sessions with the UK supply chain on the SNS decommissioning programmes and timeline.
2. The First Point Assessment (FPAL) database is the primary source for establishing tender lists for contracts / purchases valued at US\$ 100,000 and above, although it is also used under this limit.
3. Chrysaor is committed to competitively bidding all of its major contracts where possible and practicable. We are supporters of the UK Supply Chain Code of Practice and our performance in this regard has been acknowledged through Excellence Awards from Oil & Gas UK.
4. Chrysaor are active participants in various industry initiatives including:
 - a. Oil & Gas UK Supply Chain Forum;
 - b. Inventory sharing initiative (Ampelius);
 - c. OGA Decommissioning Board - Supply Chain sub-group.

2 Description of Items to be Decommissioned

2.1 Surface Facilities (Topsides and Jackets)

Table 2.1 Surface Facilities Information								
Name	Facility Type	Location	Topsides / Facilities		Jacket (if applicable)			
		WGS84 Decimal/ WGS84 Decimal Minute	Weight (Te)*	No of modules	Weight (Te)**	No of Legs	No of piles	Weight of piles (Te)***
Ganymede ZD	Fixed Steel Jacket Only	53.3240° N / 53° 19.4393' N 02.2367° E / 02° 14.2027' E	N/A	N/A	1335	4	4	254
Europa EZ	Fixed Steel Jacket	53.2471° N / 53° 14.826' N 02.2957° E / 02° 17.742' E	318	1	866	3	3	226

Note* Weights are based on structural designs and review of the Return to Scene (R2S) footage

Note** Weights are based on design drawings, include piles to mudline, (excludes marine growth, estimated at ~73Te)

Note*** Weight of piles to -3m below mudline

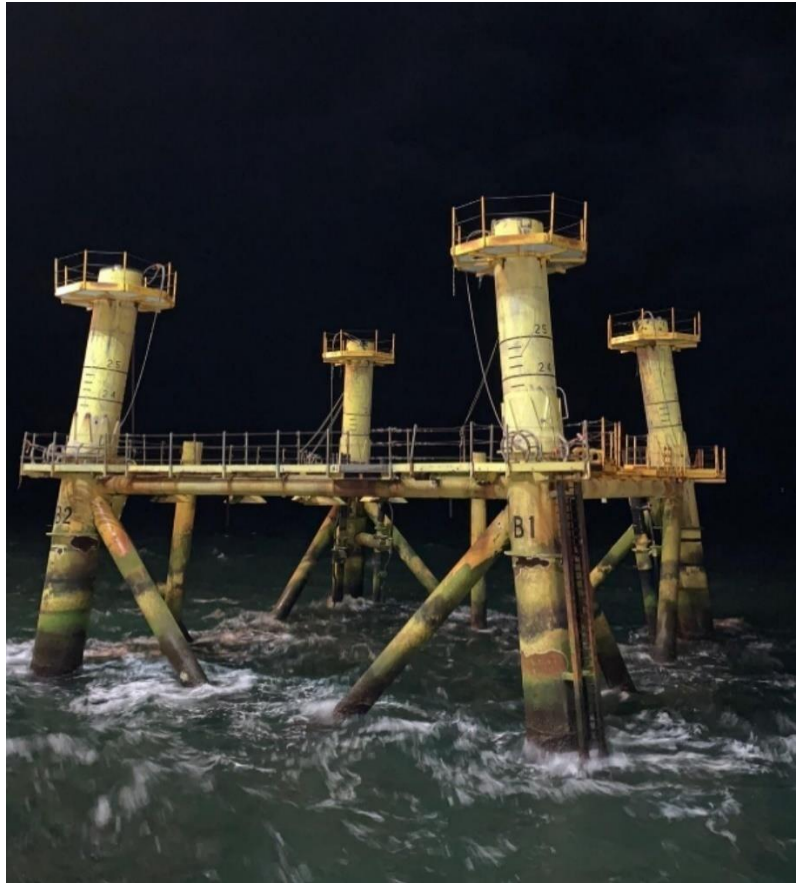

Figure 2.1.1 Photograph of Ganymede ZD Jacket



Figure 2.1.2 Photograph of Europa EZ

2.2 Subsea Installations and Stabilisation Features

Table 2.2 Subsea Installation and Stabilisation Features				
Subsea installations and stabilisation features	Number	Size / Weight (Te)	Locations	Comments / Status
			WGS84 Decimal/ WGS84 Decimal Minute	
Wellheads (in respect of Callisto ZM and NW Bell ZX)	2	-	Callisto ZM: 53.2414° N / 53° 14.4858' N 02.3865° E / 02° 23.1922' E NW Bell ZX: 53.2420° N / 53° 14.5182' N 02.3857° E / 02° 23.1435' E	Disused: NW Bell ZX and Callisto ZM
Manifolds* (in respect of Callisto ZM and NW Bell ZX)	2	Callisto ZM: 13.4x13.4x6.4m NW Bell: 12.7x12.7x6.3m	Callisto ZM: 53.2414° N / 53° 14.4858' N 02.3865° E / 02° 23.1922' E NW Bell ZX: 53.2420° N / 53° 14.5182' N 02.3857° E / 02° 23.1435' E	Disused: NW Bell ZX and Callisto ZM
Templates	1	-	53.3240° N / 53° 19.4393' N 02.2367° E / 02° 14.2027' E	Under Ganymede ZD, already removed
Protection frames* (in respect of Callisto ZM and NW Bell ZX)	2	-	Callisto ZM: 53.2414° N / 53° 14.4858' N 02.3865° E / 02° 23.1922' E NW Bell ZX: 53.2420° N / 53° 14.5182' N 02.3857° E / 02° 23.1435' E	Disused: NW Bell ZX and Callisto ZM
SSIV	0	0	None	None present
Concrete mattresses	0	0	None	None present
Grout bags	160	3200 kg	Callisto ZM: 53.2414° N / 53° 14.4858' N 02.3865° E / 02° 23.1922' E NW Bell ZX: 53.2420° N / 53° 14.5182' N 02.3857° E / 02° 23.1435' E	40 at NW Bell ZX and 120 at Callisto ZM
Formwork	0	0	None	None present
Froned mats	6	36 Te	NW Bell ZX: 53.2420° N / 53° 14.5182' N 02.3857° E / 02° 23.1435' E	NW Bell ZX
Rock dump	0	0	None	None present
Other	0	0	None	None present

Note * Manifolds are integral to the protection frame



Figure 2.2.1 Photograph of subsea Xmas tree, Callisto ZM

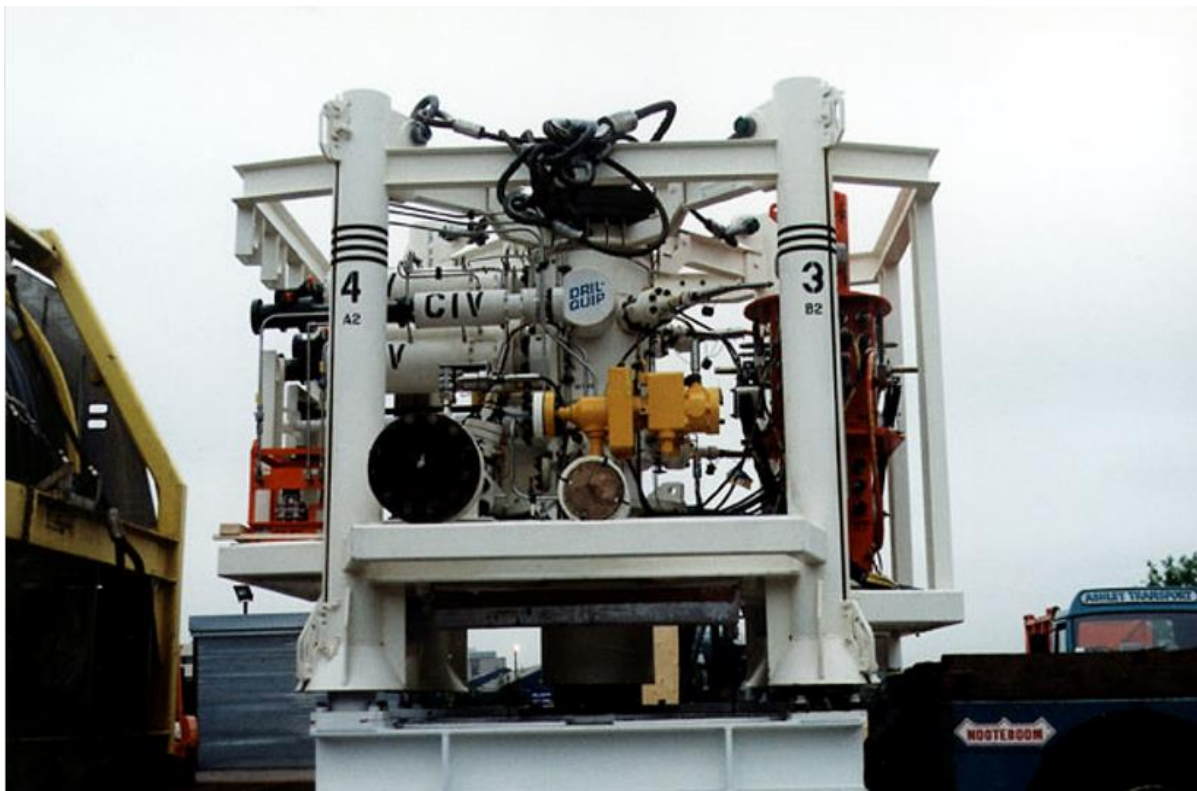

Figure 2.2.2 Photograph of subsea Xmas tree, NW Bell ZX

2.3 Pipelines Including Stabilisation Features

Table 2.3 Pipeline / Flowline / Umbilical Information									
Description	Pipeline No (as per PWA)	Diameter (inches)	Length (km)	Description of Component Parts	Product Conveyed	From – To End Points	Burial Status	Pipeline Status	Current Content
Gas Pipeline	PL1093	18	19.5	Steel pipe with coal tar enamel	Gas condensate, produced water	Ganymede ZD to LOGGS PR	Trenched and buried, 75m (0.4%) exposed*, no reportable FishSafe spans**	Out of use	Untreated seawater with <30mg/l hydrocarbons
MeOH Pipeline piggy-backed onto PL1093	PL1094	3	19.5	Steel pipe with Fusion Bonded Epoxy corrosion coating	MeOH corrosion inhibitor	LOGGS PR to Ganymede ZD	Trenched and buried, 75m (0.4%) exposed*, no reportable FishSafe spans**	Out of use	Untreated seawater
Gas Pipeline	PL1091	12	14.3	Steel pipe with coal tar enamel	Gas condensate, produced water	Callisto ZM to Ganymede ZD	Trenched and buried, 132m (1.0%) exposed*, no reportable FishSafe spans**	Out of use	Untreated seawater with <30mg/l hydrocarbons
MeOH Pipeline piggy-backed onto PL1091	PL1092	3	14.3	Steel pipe with Fusion Bonded Epoxy corrosion coating	MeOH corrosion inhibitor	Ganymede ZD to Callisto ZM	Trenched and buried, 132m (1.0%) exposed*, no reportable FishSafe spans**	Out of use	Untreated seawater
Umbilical	PLU4178 (UM2)	Nominal 4"	14.0	Electric bundle surrounded by hydraulic hoses that are bound and protected by layers of steel armour wires, bitumen coated fibres and an	Hydraulic Controls Fluids	Ganymede ZD to Callisto ZM	Trenched and buried, 11m (0.1%) exposed*, no reportable FishSafe spans**	Out of use	Untreated seawater

Table 2.3 Pipeline / Flowline / Umbilical Information

Description	Pipeline No (as per PWA)	Diameter (inches)	Length (km)	Description of Component Parts	Product Conveyed	From – To End Points	Burial Status	Pipeline Status	Current Content
				outer LDPE sheath					
Gas Pipeline	PL1694	12	4.5	Steel pipe with 3 Layer Polypropylene corrosion coating	Gas condensate, produced water	Europa EZ to PL1091 Tee	Trenched and buried, 4m (0.1%) exposure, no reportable FishSafe spans**	Out of use	Untreated seawater with <30mg/l hydrocarbons
MeOH Pipeline piggy-backed onto PL1694	PL1695	3	4.5	Steel pipe with 3 Layer Polypropylene corrosion coating	MeOH corrosion inhibitor	PL1091 Tee to Europa EZ	Trenched and buried, 4m (0.1%) exposure, no reportable FishSafe spans**	Out of use	Untreated seawater
Subsea Sinope tee between Europa EZ and PL1091	N/A	N/A	N/A		Gas condensate, produced water			N/A	Flush fluid ingress prevention gel plug to be discharged to sea upon subsea disconnect
Subsea pigging skid at Sinope tee between Europa EZ and PL1091	N/A	N/A	N/A		Gas condensate, produced water			N/A	Flush fluid ingress prevention gel plug to be discharged to sea upon subsea disconnect
Gas Pipeline	PL1690	8	0.1	Steel pipe with 3 Layer Polypropylene corrosion coating	Gas condensate, produced water	NW Bell ZX to Callisto ZM	Surface laid and overlaid by concrete mattresses, 8m (9%) exposure, no reportable FishSafe spans**	Out of use	Untreated seawater

Table 2.3 Pipeline / Flowline / Umbilical Information

Description	Pipeline No (as per PWA)	Diameter (inches)	Length (km)	Description of Component Parts	Product Conveyed	From – To End Points	Burial Status	Pipeline Status	Current Content
MeOH Pipeline piggy-backed onto PL1690	PL1691	3	0.1	Steel pipe with 3 Layer Polypropylene corrosion coating	MeOH corrosion inhibitor	Callisto ZM to NW Bell ZX	Surface laid and overlaid by concrete mattresses, 8m (9%) exposure, no reportable FishSafe spans**	Out of use	Untreated seawater
Umbilical	PLU4177 (UM3)	Nominal 4"	0.1	Electric bundle surrounded by hydraulic hoses that are bound and protected by layers of steel armour wires, bitumen coated fibres and an outer LDPE sheath	Hydraulic Controls Fluids	Callisto ZM to NW Bell ZX	Surface laid and overlaid by concrete mattresses, no exposure, no reportable FishSafe spans**	Out of use	Untreated seawater

*Note ** As per pipeline survey length

*Note *** As per FishSAFE span reporting criteria: 'significant' pipeline spans (i.e. over 10m long and 0.8m above the seabed)

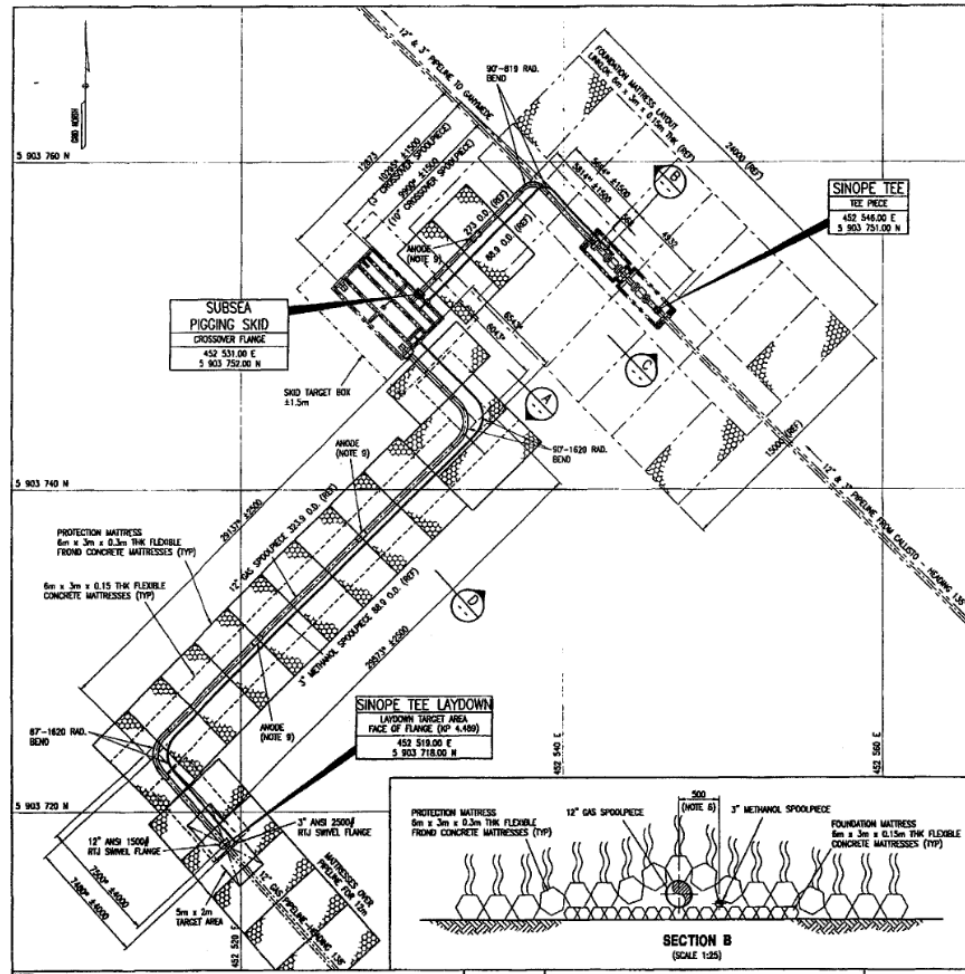

Figure 2.3.1 Schematic showing the layout of the Sinope subsea tee and pigging skid

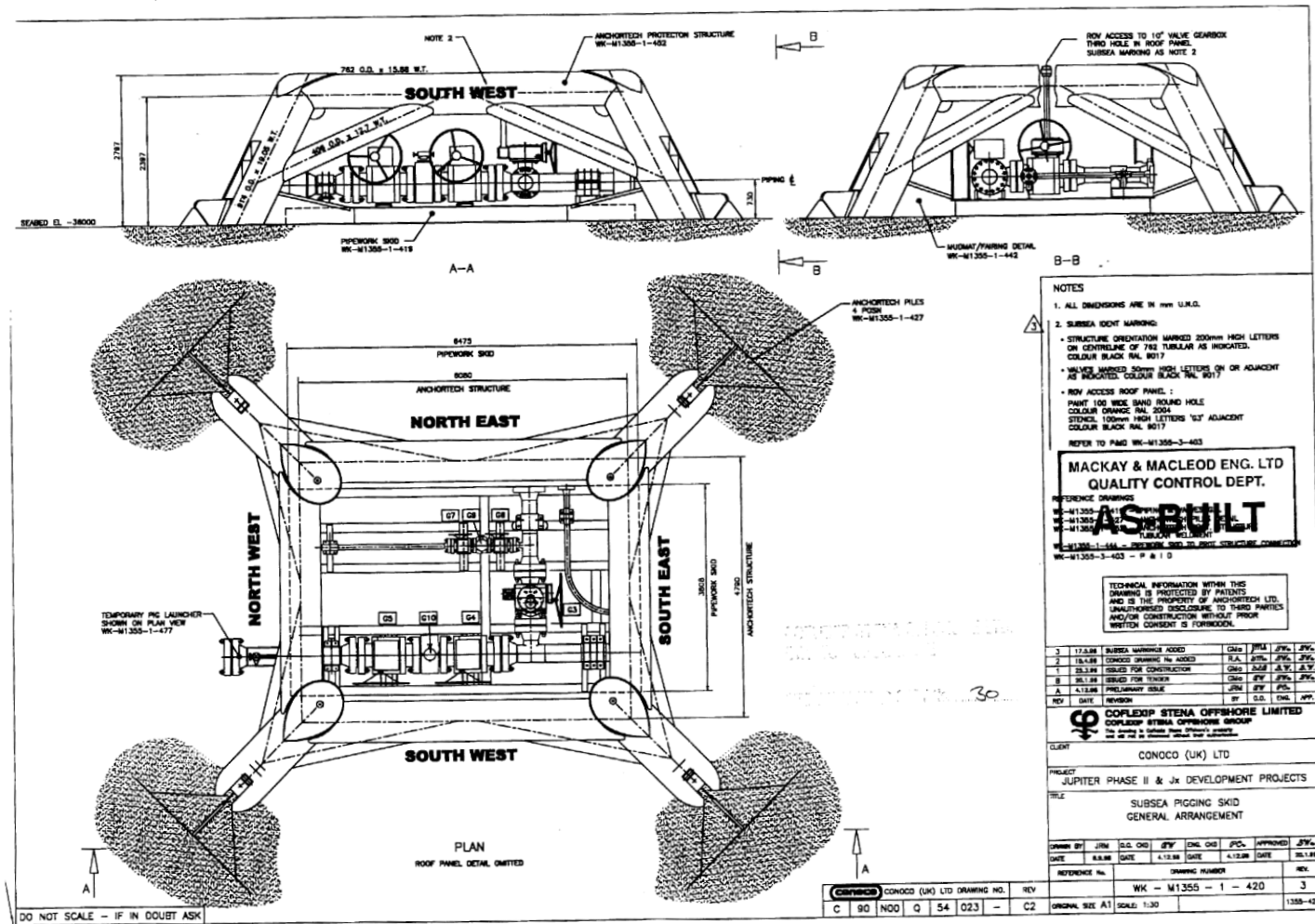

Figure 2.3.2 Schematic of Sinope Pigging Skid



Figure 2.3.3 Photographs of Sinope Tee

Table 2.4 Subsea Pipeline Stabilisation Features

Stabilisation Feature	Total Number/ Length*	Weight (Te)*	Locations	Exposed / Buried / Condition
Concrete Mattresses	1/3m	6	PL1091 & PL1092 at KP-0.040 - KP-0.037	Exposed in 2006
	6/16m	36	PL1091 & PL1092 at KP-0.035 - KP-0.019	Partially buried in 2006, polypropylene rope
	1/3m	6	PL1091 & PL1092 at KP-0.019 - KP-0.018	Partially buried in 2006, polypropylene rope
	1/3m	6	PL1091 & PL1092 at KP-0.016 - KP-0.015	Partially buried in 2006, polypropylene rope
	2/6m	12	PL1091 & PL1092 at KP-0.015 - KP-0.011	Partially buried in 2006, polypropylene rope, extensive soft marine growth
	3/10m	18	PL1091 & PL1092 at KP0.017 - KP-0.027	Partially buried in 2006 and 2011
	2/5m	12	PL1091 & PL1092 at KP7.908 - KP7.913	Partially buried in 2011
	1/3m	6	PL1091 & PL1092 at KP7.923 - KP7.926	Partially buried in 2011
	3/10m	18	PL1091 & PL1092 at KP14.106 - KP14.116	Partially buried in 2011 and 2015, partially degraded
	8/24m	48	PL1091 & PL1092 at KP14.144 - KP14.168	Partially buried in 2015, partially degraded, steel connections
	1/3m	6	PL1091 & PL1092 at KP14.153 - KP14.156	Partially buried in 2011, steel connections
	1/3m	6	PL1091 & PL1092 at KP14.165 - KP14.168	Partially buried in 2015
1/3m	6	PL1091 & PL1092 at KP14.174 - KP14.177	Partially buried in 2011, partially degraded	
Concrete Mattresses	1/3m	6	PL1093 & PL1094 at KP19.167 - KP19.170	Partially buried in 2014, linklok mattresses
	1/3m	6	PL1093 & PL1094 at KP19.170 - KP19.173	Partially buried in 2014, short block concrete mattresses

Table 2.4 Subsea Pipeline Stabilisation Features

Stabilisation Feature	Total Number/ Length*	Weight (Te)*	Locations	Exposed / Buried / Condition
	1/3m	6	PL1093 & PL1094 at KP19.182 - KP19.185	Partially buried in 2014, short block concrete mattresses with steel connection rope
	1/5m	6	PL1093 & PL1094 at KP19.227 - KP19.232	Partially buried in 2014, short block concrete mattresses
Concrete Mattresses	1/5m	6	PL1690 & PL1691 at KP0.001 - KP0.005	Partially buried in 2009 and 2012, short block concrete mattresses
	17/51m	102	PL1690 & PL1691 at KP0.030 - KP0.081	Partially buried in 2009 and 2012, short block concrete mattresses, polypropylene rope construction
	3/8m	18	PL1690 & PL1691 at KP0.087 - KP0.095	Partially buried in 2009, short block concrete mattresses, polypropylene rope construction
Concrete Mattresses	2/6m	12	PL1694 & PL1695 at KP-0.050 - KP-0.044	Visible in 2012
	1/2m	6	PL1694 & PL1695 at KP-0.019 - KP-0.017	Partially buried in 2012
	1/3m	6	PL1694 & PL1695 at KP-0.015 - KP-0.011	Partially buried in 2012
	11/34m	66	PL1694 & PL1695 at KP4.497 - KP4.531	Exposed in 2006
Concrete Mattresses	2/11m	12	PLU4178 at KP0.021 - KP0.010	Partially buried in 2008, covered in extensive marine growth, partially degraded
	2/11m	12	PLU4178 at KP0.067 - KP0.078	Partially buried in 2012, covered in extensive marine growth, partially degraded
	4/11m	24	PLU4178 at KP13.830 - KP13.841	Partially buried in 2008

Table 2.4 Subsea Pipeline Stabilisation Features

Stabilisation Feature	Total Number/ Length*	Weight (Te)*	Locations	Exposed / Buried / Condition
Concrete Mattresses	1/4m	6	PLU4177 at KP0.000 - KP0.004	Visible in 2012
	11/33m	66	PLU4177 at KP0.030 - KP0.063	Partially buried in 2012
	6/17m	36	PLU4177 at KP0.067 - KP0.084	Partially buried in 2012
Concrete Mattresses	7	42	Sinope Tee and Pigging Skid	
Grout Bags	1	20 kg	PL1093 & PL1094 at KP17.660 - KP17.661	Partially buried in 2012
Grout Bags	2	40 kg	PLU4177 at KP0.074 - KP0.076	Visible in 2012
Grout Bags	40	800 kg	Sinope Tee and Pigging Skid	
Formwork	None	-	-	-
FronD Mats	6/18m	36	PL1091 & PL1092 at KP-0.008 - KP0.010	Partially buried in 2006, polypropylene rope
	2/6m	12	PL1091 & PL1092 at KP7.925	Partially buried in 2011
FronD Mats	10/30m	60	PL1690 & PL1691 at KP0.005 - KP0.035	Partially buried in 2009 and 2012
	3/10m	18	PL1690 & PL1691 at KP0.077 - KP0.087	Partially buried in 2009 and 2012, short block concrete mattresses
FronD Mats	8/25m	48	PL1694 & PL1695 at KP-0.044 - KP-0.019	Visible in 2012
	1/2m	6	PL1694 & PL1695 at KP-0.017 - KP-0.015	Partially buried in 2012
	5/15m	30	PL1694 & PL1695 at KP-0.001 - KP0.014	Exposed in 2006 and 2012
	13/39m	78	PL1694 & PL1695 at KP4.483 - KP4.522	Partially buried in 2006 and 2012

Table 2.4 Subsea Pipeline Stabilisation Features

Stabilisation Feature	Total Number/ Length*	Weight (Te)*	Locations	Exposed / Buried / Condition
	1/1m	6	PL1694 & PL1695 at KP4.531 - KP4.532	Partially buried in 2006
Froned Mats	1/3m	6	PLU4178 at KP13.864	Exposed in 2008
Froned Mats	6/17m	36	PLU4177 at KP0.004 - KP0.021	Visible in 2012
Froned Mats	24	144	Sinope Tee and Pigging Skid	
Rock Dump	4m		PL1091 & PL1092 at KP-0.045 – KP-0.041	Partially buried in 2006 and 2011
	117m		PL1091 & PL1092 at KP0.011 - KP0.128	Partially buried in 2006 and 2011
	215m		PL1091 & PL1092 at KP4.884 - KP5.099	Partially buried in 2011
	73m		PL1091 & PL1092 at KP5.110 - KP5.183	Partially buried in 2011
	59m		PL1091 & PL1092 at KP5.190 - KP5.249	Partially buried in 2011
	120m		PL1091 & PL1092 at KP7.764 - KP7.884	Partially buried in 2011
	16m		PL1091 & PL1092 at KP7.888 - KP7.904	Partially buried in 2011
	3m		PL1091 & PL1092 at KP7.923 - KP7.926	Partially buried in 2011
	135m		PL1091 & PL1092 at KP7.926 - KP8.058	Partially buried in 2011
	11m		PL1091 & PL1092 at KP12.042 - KP12.053	Partially buried in 2011, <i>Sabellaria spinulosa</i> present
	32m		PL1091 & PL1092 at KP12.075 - KP12.107	Partially buried in 2011, <i>Sabellaria spinulosa</i> present
	34m		PL1091 & PL1092 at KP13.966 - KP14.000	Partially buried in 2015
	104m		PL1091 & PL1092 at KP14.002 - KP14.106	Partially buried in 2011 and 2015
30m		PL1091 & PL1092 at KP14.112 - KP14.142	Partially buried in 2011 and 2015	
15m		PL1091 & PL1092 at KP14.168 - KP14.193	Partially buried in 2011 and 2015	
Rock Dump	5m		PL1093 & PL1094 at KP-0.035 - KP-0.030	Partially buried in 2015
	145m		PL1093 & PL1094 at KP-0.010 - KP0.135	Partially buried in 2015
	55m		PL1093 & PL1094 at KP10.797 - KP10.852	Partially buried in 2012

Table 2.4 Subsea Pipeline Stabilisation Features

Stabilisation Feature	Total Number/ Length*	Weight (Te)*	Locations	Exposed / Buried / Condition
	34m		PL1093 & PL1094 at KP13.384 - KP13.418	Partially buried in 2012
	122m		PL1093 & PL1094 at KP14.298 - KP14.420	Partially buried in 2012
	24m		PL1093 & PL1094 at KP14.434 - KP14.458	Partially buried in 2012
	10m		PL1093 & PL1094 at KP14.508 - KP14.518	Partially buried in 2012
	19m		PL1093 & PL1094 at KP14.684 - KP14.703	Partially buried in 2012, with damaged <i>S.Spinulosa</i> present
	11m		PL1093 & PL1094 at KP18.926 - KP18.937	Partially buried in 2014
	5m		PL1093 & PL1094 at KP18.945 - KP18.950	Partially buried in 2014
	59m		PL1093 & PL1094 at KP18.958 - KP19.017	Partially buried in 2014
	14m		PL1093 & PL1094 at KP19.031 - KP19.045	Partially buried in 2014
	22m		PL1093 & PL1094 at KP19.122 - KP19.144	Partially buried in 2014
	69m		PL1093 & PL1094 at KP19.173 - KP19.242	Partially buried in 2014, interspersed with mattresses
Rock Dump	4m		PL1690 & PL1691 at KP0.052 - KP0.056	Partially buried in 2009
	2m		PL1690 & PL1691 at KP0.079 - KP0.081	Partially buried in 2009
Rock Dump	95m		PL1694 & PL1695 at KP0.014 - KP0.109	Partially buried in 2006
	32m		PL1694 & PL1695 at KP2.743 - KP2.775	Partially buried in 2006 and buried in 2012
	69m		PL1694 & PL1695 at KP3.973 - KP4.042	Buried in 2006 and 2012
	110m		PL1694 & PL1695 at KP4.373 - KP4.483	Partially buried in 2006 and 2012
Rock Dump	1m		PLU4178 at KP13.610	Sighting in 2008
	1m		PLU4178 at KP13.924	Sighting in 2012
Bitumen/ grout mattresses				
Debris	10m		PL1091 & PL1092 at KP7.913 - KP7.923	Possible protective structure for the tee piece tie-in that has not been removed, observed in 2011

Table 2.4 Subsea Pipeline Stabilisation Features

Stabilisation Feature	Total Number/ Length*	Weight (Te)*	Locations	Exposed / Buried / Condition
Debris			PL1093 & PL1094 at KP19.194	Scaffolding pole port side of pipeline, observed in 2014
Debris			PLU4178 at KP10.224	Hard debris: white plastic cuboid object, observed in 2008

Note * The total number and weight for mattresses have been estimated from the visual survey data and based on a typical mattress size of 6m by 3m and weight of 6 Te. Grout bag and Rock Dump have also been estimated from visual survey data.

2.4 Wells

Table 2.5 Well Information			
CM Platform Wells	Designation	Status	Category of Well
49/22-Z01Z - Ganymede Field	Gas Production	AB3	PL 3-3-3
49/22-Z02Z - Ganymede Field	Gas Production	AB3	PL 3-3-3
49/22-Z03 - Ganymede Field	Gas Production	AB3	PL 3-3-3
49/22-Z04 - Ganymede Field	Gas Production	AB3	PL 3-3-3
49/22-Z05Z - Ganymede Field	Gas Production	AB3	PL 3-3-3
49/22-Z06 - Ganymede Field	Gas Production	AB3	PL 3-3-3
49/22-Z07 - Ganymede Field	Gas Production	AB3	PL 3-3-3
49/22-Z08 - Ganymede Field	Gas Production	AB3	PL 3-3-3
49/22-N01Y - Europa Field	Gas Production	AB3	PL 3-3-3
49/22-N02Z - Europa Field	Gas Production	AB3	PL 3-3-3
49/22-N03 - Sinope Field	Gas Production	AB3	PL 3-3-3
49/22-N04 - Europa Field	Gas Production	AB3	PL 3-3-3
49/22-N05 - Europa Field	Gas Production	AB3	PL 3-3-3
49/22-N06 - Callisto North Field	Gas Production	AB3	PL 3-3-3
Subsea Wells	Designation	Status	Category of Well
49/22-6Z (Callisto ZM) - Callisto Field	Gas Production	Shut in	SS 3-3-3
49/22-20y (NW Bell ZX) - Callisto North Field	Gas Production	Shut in	SS 3-3-3

For further details of well categorisation see OGUK guidelines “Well Decommissioning Guidelines” – Issue 6 – June 2018.

2.5 Drill Cuttings

Table 2.6 Drill Cuttings Pile Information		
Location of Pile Centre (Latitude / Longitude)	Seabed area (m ²)	Estimated volume of cuttings (m ³)
None of the facilities has a cuttings pile present	0	0

No drill cuttings have been identified on the seabed adjacent to the installations in subsea inspections conducted in 1994, 2000 and 2015. The dynamic marine environment has resulted in the redistribution of drill cuttings.

2.6 Inventory Estimates

Table 2.7 Current Installation Material Functional Category Summary							
Installation	Haz Mat / NORM	Concrete	Ferrous Metal	Non-Ferrous Metal	Plastics	Other Non-Haz	Total
	Te	Te	Te	Te	Te	Te*	Te
Ganymede ZD Jacket	3	254	1278	12	0	43	1589
Europa EZ	21	226	1102	8	1	51	1410
Total	24	480	2380	20	1	94	2999

*Note** Weights exclude the estimated ⁷³Te marine growth associated with all platform jackets

Table 2.8 Pipeline Riser Material Functional Category Summary							
Pipeline No	Description	Haz Mat / NORM Te	Concrete Te	Ferrous Metal Te	Non-Ferrous Metal Te	Plastics Te	Other Non-Haz Te
PL1093	Ganymede ZD to LOGGS PR Gas	221	5106	4634			
PL1094	LOGGS PR to Ganymede ZD MeOH			458		5	
PL1091	Callisto ZM to Ganymede ZD Gas	116	2086	1825			
PL1092	Ganymede ZD to Callisto ZM MeOH			338		4	
PLU4178	Ganymede ZD to Callisto ZM Umbilical			189	7	68	
PL1694	Europa EZ to PL1091 Tee Gas			587		9	
PL1695	PL1091 Tee to Europa EZ MeOH			95		2	
PL1690	NW Bell ZX to Callisto ZM Gas			10		0	
PL1691	Callisto ZM to NW Bell ZX MeOH			2		1	
PLU4177	Callisto ZM to NW Bell ZX Umbilical			1	0	0	
	Subsea tee between Europa EZ and Callisto to Ganymede pipeline			40			
	Mattresses		1104				
Total		337	8296	8179	7	89	0

Preparation / Cleaning: Table 3.1 describes the methods that will be used to flush, purge and clean the topsides offshore, prior to removal to shore.

Table 3.1 Cleaning of Topsides for Removal		
Waste Type	Composition of Waste	Disposal Route
Hydrocarbons	Process fluids	Will be flushed, Nitrogen purged vented and made liquid free.
Produced solids	Sand, NORM	Any pipeline debris captured in filter packages, will be returned onshore for disposal. Any solids remaining in vessels will be removed and disposed of during the dismantlement of the Topsides onshore.
Diesel	Bunkered Diesel fuel	Bunkered Diesel will be drained and returned onshore for re-use or disposal.
Lubricating oils	Lubricants for equipment e.g. gearboxes, pumps, pedestal crane compressor skid	Lubricating oils will be drained and returned onshore for re-use or disposal.

3.1.2 Topsides Removal Methods

Given the size and combined weight of the LOGGS Satellites the Topsides and Jackets will be removed using multiple lifts.

Table 3.2 Topsides Removal Methods	
<input checked="" type="checkbox"/> 1) HLV (semi-submersible crane vessel) <input checked="" type="checkbox"/> 2) Monohull crane vessel <input checked="" type="checkbox"/> 3) SLV <input checked="" type="checkbox"/> 4) Piece small <input checked="" type="checkbox"/> 5) Other Simultaneous removal of Topsides with Jacket	
Methods Considered	Description
Single lift removal complete with Jacket by HLV / Monohull crane vessel / SLV	Removal of Topsides complete with Jacket in a single lift and transportation to shore for dismantlement, disposal and recycling.
Modular lift removal of Topsides by HLV / Monohull crane vessel / SLV	Removal of Topsides for transportation to shore for dismantlement, disposal and recycling.
Offshore removal "piece small" for onshore disposal	Removal of Topsides and dismantlement offshore for transportation onshore for disposal and recycling.
Proposed removal method and disposal route.	EZ Topsides will be removed in one or more lifts. Transportation to shore for dismantlement, disposal and recycling. Trans-frontier shipments will not be required

Note: Option Considered

3.2 Jackets

There are 2 different jacket designs in this decommissioning programme:

- The Ganymede ZD platform is of a 4-leg steel conventional design
- The Europa EZ jacket is a 4 leg Vierendeel tower design.

3.2.1 Jacket Decommissioning Overview

All jackets to be removed to 3m below the seabed.

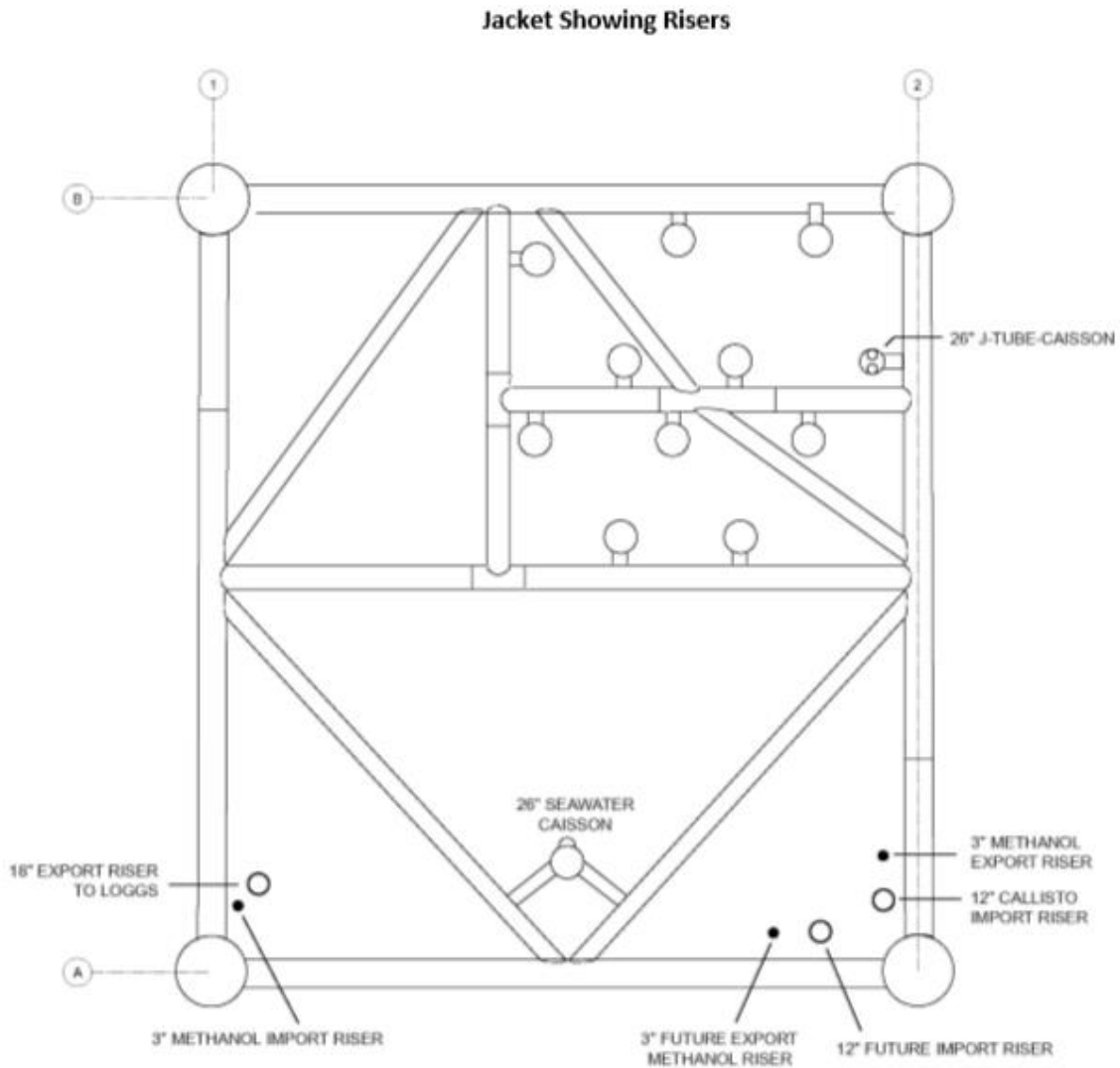

Figure 3.2.1 Ganymede ZD Jacket Showing Risers

Europa Jacket Showing Risers

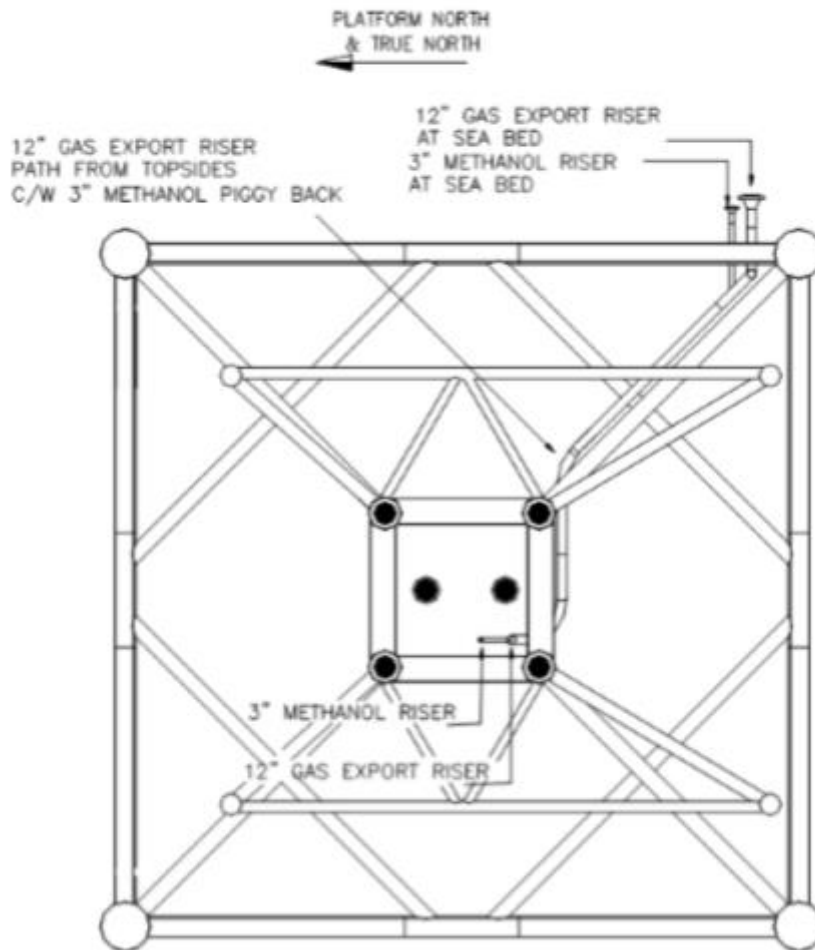

Figure 3.2.2 EZ Jacket

3.2.2 Jacket Removal Methods

Table 3.3 Jacket Removal Methods	
<input checked="" type="checkbox"/> 1) HLV (semi-submersible crane vessel) <input checked="" type="checkbox"/> 2) Monohull crane vessel <input checked="" type="checkbox"/> 3) SLV <input checked="" type="checkbox"/> 4) Piece small <input checked="" type="checkbox"/> 5) Other: Simultaneous removal of Topsides with Jacket	
Method	Description
Jacket Piles cut 3m below seabed and removed via single lift complete with Topsides by HLV / Monohull crane vessel / SLV	Jacket Piles cut 3m below seabed. Removal of Jacket complete with Topsides in a single lift and transportation to shore for dismantlement, disposal and recycling.
Jacket Piles cut 3m below seabed and removed via single lift by HLV / Monohull crane vessel / SLV	Jacket Piles cut 3m below seabed. Removal of Jacket in a single lift and transportation to shore for dismantlement, disposal and recycling.
Offshore removal "piece small" for onshore disposal	Jacket Piles cut 3m below seabed. Removal of Jacket and dismantlement offshore for transportation onshore for disposal and recycling.
Proposed removal method and disposal route.	<p>Jacket Piles cut 3m below seabed.</p> <p>Removal of Jackets complete using a single lift.</p> <p>Removal to be undertaken with a heavy lift vessel.</p> <p>Transportation to shore for dismantlement, disposal and recycling.</p> <p>Trans-frontier shipments will not be required</p>

Note: Option Considered.

3.3 Subsea Installations and Stabilisation Features

Table 3.4 Subsea Installations and Stabilisation features			
Subsea installations and stabilisation features	Number	Option	Disposal Route
Wellheads	2	Full Removal	Removed and transported to appropriate land-based facility for dismantlement, recycling and disposal.
Manifolds*	2	Full Removal	Removed and transported to appropriate land-based facility for dismantlement, recycling and disposal.
Templates	1	Full Removal	Removed and transported to appropriate land-based facility for dismantlement, recycling and disposal.
Protection frames	2	Full Removal	Removed and transported to appropriate land-based facility for dismantlement, recycling and disposal.
SSIV	0	None	None
Concrete mattresses	0	None	None
Grout bags	160	Full Removal	Removed and transported to appropriate land-based facility for dismantlement, recycling and disposal.
Formwork	0	None	None
Froned mats	6	Full Removal	Removed and transported to appropriate land-based facility for dismantlement, recycling and disposal.
Rock dump	0	None	None
Other	0	None	None

*Note** Manifold is integral to the Protection frame

3.4 Pipelines

3.4.1 Comparative Assessment Method

The purpose of the comparative assessment was to identify the best overall option for decommissioning of each of the ten pipelines included within the scope of the decommissioning programme in view of the pipeline status, condition and environmental setting.

A two-phase approach was undertaken to evaluate the decommissioning approach to be undertaken. Independently chaired workshops were conducted to evaluate the feasibility of decommissioning options and then to qualitatively compare the data of five criteria using a pair-wise methodology.

Initially 10 decommissioning options were identified and considered by Chrysaor for assessment of technical feasibility of the decommissioning of the infield pipelines; these were as follows:

1. Decommission in-situ – minimum intervention (physical intervention at pipeline ends only)
 - a. Removal of pipeline ends and rock placement/ burial of cut ends only
 - b. As 1a but also the introduction of a corrosive substance to accelerate decomposition
2. Decommission in-situ – minor intervention (physical intervention at pipeline ends and remediation of snagging hazards only)
 - a. Removal of pipeline ends and rock placement over cut ends and all exposed pipeline sections
 - b. Removal of pipeline ends and re-burial of all cut ends and exposed pipeline sections
3. Decommission in-situ – major intervention (physical intervention at pipeline ends and remediation of full pipeline length)
 - a. Removal of pipeline ends and rock cover over the full pipeline
 - b. Removal of pipeline ends and re-trenching and burial of the full pipeline length
4. Partial removal – cut and lift (physical intervention at pipeline ends and removal by cut and lift of all pipeline exposure)
 - a. Exposed pipeline sections removed by cut and lift and rock cover over exposed pipeline ends
5. Full removal – reverse installation
 - a. Full removal by reverse reel
 - b. Full removal by reverse s-lay
6. Full removal – cut and lift
 - a. Full pipeline removal by cut and lift techniques

Note:

Leave in Situ Minimum Intervention entails: Post flushing, the remaining pipeline would be left in its current state, marked on sea charts and notifications issued to fishermen / other users of the sea. All mattresses would be left in situ in their current state to maintain pipeline stabilisation, minimise disturbance of the established environment and reduce the requirement for the introduction of new material to the SACI. Pipelines would be left open and flooded with seawater.

Leave in Situ Minor Intervention entails: Post flushing, the pipelines decommissioned in situ would be left in such a manner that they do not pose a risk to other users of the sea. Pipelines would be left open and flooded with seawater.

Options 1b, 2b, 3a, 3b and 5b were excluded from the evaluation phase for all the pipeline groupings:

- Option 1b: Accelerated decomposition was screened out of all options as the concept is un-proven and the impact of potential chemical agents into the marine environment is not understood and cannot be quantified.
- Option 2b: Burial of exposed ends and pipeline sections is not considered a permanent solution for the pipelines in this location due to the dynamic seabed movement, rendering a burial solution vulnerable to unburial over time.
- Option 3a: Rock cover over the full pipeline length is not considered a feasible solution as large magnitude rock cover is considered detrimental to the free movement of sand in the protected area.
- Option 3b: Reburial of the full pipeline length is not considered a permanent solution due to the dynamic seabed movement, rendering a burial solution vulnerable to unburial over time.

Trench and re-burial (Options 2b and 3b) was discounted because there is no information that is known of these pipelines to suggest that sufficient burial will result in no subsequent exposure in this area where dynamic seabed conditions persist (shallow water, strong tidal influence with mega-ripple sediment features).

There is a lot of uncertainty associated with the chance of success in the achievement of burial of pipeline ends and exposures in this dynamic seabed environment. As the assets were trenched and buried in the construction phase, it is unlikely that re-burial will achieve permanent burial of exposures. Despite advances in pipelaying techniques since the time of installation, the methods used for the burial of these types of pipelines within the dynamic area have not changed significantly to increase the level of assurance that the pipelines will remain buried. Furthermore, in this locality the dynamic seabed is the dominant factor that influences pipeline exposure (with the exception of the 36" trunkline which was trenched and left to backfill naturally, also contributing to the exposures present).

The analysis of the pipeline depth of cover survey information does not appear to correlate between installation burial depth and areas of exposure. This is evident in the LOGGS area where surficial soils are generally hard and sandy but of varying depths overlaying clay. If reburial were to be attempted, the localised variability of the soil and seabed profile contributes to the uncertainty of success of permanent burial.

The burial under natural sediment of pipeline ends has also been discounted for the same reasons (Options 2b and 3b) as this option will require an unknown length and depth of pipeline trenching and excavation back to sufficient depth to ensure some degree of success. Furthermore trenching and burial will result in widespread, short term disturbance of the seabed within the marine protected area with limited long term success.

Due to the dynamic seabed environment, rock remediation on pipeline ends is expected to provide the safest profile for other users of the sea. Re-burial under natural sediment is not considered a permanent solution in the dynamic seabed conditions exposing other users of the sea to potential snag hazards should unburial of ends occur.

Rock cover over the full pipeline was excluded from the evaluation phase for all the pipeline groupings. The key reason for discounting this option was the impact of permanent habitat loss associated with the deposit of hard substrate within the marine protected area. The placement of rock material is still considered feasible in other options selected for further consideration on the basis that the options provide a high certainty of long term success whilst the impact of habitat loss through the deposit of hard substrate is localised in comparison. Whilst rock deposits provide long term success, the potential for rock influenced scour adjacent to the deposits has been considered in the comparative assessment of the feasible options.

- Option 5b: Full removal by reverse s-lay is considered technically unproven for rigid steel pipelines with unknown integrity.

For flexible pipelines, reverse reel was considered more appropriate than reverse s-lay. The reverse s-lay of pipelines with a potentially compromised integrity due to age is deemed to pose unnecessary risk to vessel personnel whilst the pipeline is under tension and when handling on deck. This technique is unproven for decommissioning of similar pipelines.

Based on technical feasibility and the risk of major operations failure, the decommissioning options progressed to the second phase of the comparative assessment were reduced to six options.

1. Decommission in-situ – minimum intervention (physical intervention at pipeline ends only)
 - a. Removal of pipeline ends and rock placement/ burial of cut ends only
2. Decommission in-situ – minor intervention (physical intervention at pipeline ends and remediation of snagging hazards only)
 - a. Removal of pipeline ends and rock placement over cut ends and all exposed pipeline sections
4. Partial removal – cut and lift (physical intervention at pipeline ends and removal by cut and lift of all pipeline exposure)
 - a. Exposed pipeline sections removed by cut and lift and rock cover over exposed pipeline ends
5. Full removal – reverse installation
 - a. Full removal by reverse reel
6. Full removal – cut and lift
 - a. Full pipeline removal by cut and lift techniques

These decommissioning options, deemed to be technically feasible, were carried forwards through the comparative assessment process and compared in terms of pre-defined selection criteria namely safety, environmental impacts including energy and atmospheric emissions, technical feasibility, socio-economic impacts and cost.

3.4.2 Pipeline Decommissioning Options

In recognition of the environmental sensitivities in the area where pipeline decommissioning will take place, supplementary information in support of the Comparative Assessment and associated information within this Decommissioning Programme has been provided to OPRED. This information comprises pipeline as-laid status, trends in pipeline exposure, trends in pipeline burial depth and pipeline location in relation to sandbank features.

Table 3.5: Pipeline or Pipeline Groups / Decommissioning Options

Pipeline or Group (as per CA)	Condition of line / group	Whole or part of pipeline / group	Decommissioning Options considered*
<p>Group 2: PL1690, PL1691, PLU4177 (UM3)</p> <p>80m sections between the Callisto ZM and NW Bell subsea manifolds.</p>	<p>Short section, Surface laid.</p> <p>Pipelines are mattress-covered with rock cover over minor sections.</p>	Full pipeline group	1a, 6a
<p>Group 3a: PL1694, PL1695</p> <p>Europa EZ to ZM-ZD tee gas export and piggybacked methanol import pipelines.</p>	<p>≤16" Diameter, trenched, rigid non-concrete coated piggybacked pipelines.</p> <p>Pipelines in burial.</p>	Part of pipeline group (other pipelines in the CA group form part of other decommissioning programmes)	1a, 5a, 6a
<p>Group 3c: PL1091, PL1092</p> <p>Callisto ZM to Ganymede ZD gas export and piggybacked methanol import pipelines.</p>	<p>≤16" Diameter, trenched, concrete coated piggybacked pipelines.</p> <p>Pipelines with variable minor exposure. No infield spanning.</p>	Part of pipeline group (other pipelines in the CA group form part of other decommissioning programmes)	1a, 2a, 4a, 6a
<p>Group 4: PL1093, PL1094</p> <p>Ganymede ZD to LOGGS PR gas export and piggybacked methanol import pipelines.</p>	<p>>16" Diameter, trenched, concrete coated piggybacked pipelines.</p> <p>Pipelines with variable minor exposure. No infield spanning.</p>	Part of pipeline group (other pipelines in the CA group form part of other decommissioning programmes)	1a, 2a, 4a, 6a

Table 3.5: Pipeline or Pipeline Groups / Decommissioning Options			
Pipeline or Group (as per CA)	Condition of line / group	Whole or part of pipeline / group	Decommissioning Options considered*
Group 7: PLU4178 (UM2) Ganymede ZD to Callisto ZM umbilical	Trenched and buried umbilical. Umbilical with persistent minor exposure midline. No infield spanning.	Full pipeline group	1a, 2a, 4a, 5a
Subsea Tee and Pigging Skid Junction between Europa EZ and ZD-ZM pipeline.	Installed on seabed	Not part of CA. Subsea tee and pigging skid to be removed to shore.	Full Removal

* Key to Options:

- 1a) Leave in situ (minimum intervention to stabilise pipeline ends only)
- 2a) Leave in situ (minor intervention with rock cover over exposures)
- 4a) Partial removal (removal of exposures)
- 5a) Full removal (reverse reel)
- 6a) Full removal (cut and lift)

Table 3.6: Outcomes of Comparative Assessment		
Pipeline or Group	Recommended Option*	Justification
Group 2: PL1690, PL1691, PLU4177 (UM3) 80m sections between the Callisto ZM and NW Bell subsea manifolds.	Option 6a: Full Removal by cut and lift. Pipelines and associated mattresses to be fully removed.	Pipelines and associated mattresses were subject to a formal comparative assessment which concluded that both full removal (Option 6a) and leave in situ (minimum intervention) (Option 1a) of the short 80m pipelines by cut and lift were the preferred options. Results for both full removal and leave in-situ were similar against all criteria. Despite the technical challenges associated with pipeline unburial for removal and the greater cost, full removal was selected as it minimized the requirement for additional rock to stabilize the exposed pipeline ends in the protected area resulting in less habitat loss than leave in-situ.

Table 3.6: Outcomes of Comparative Assessment

Pipeline or Group	Recommended Option*	Justification
<p>Group 3a: PL1694, PL1695</p> <p>Europa EZ to ZM-ZD tee gas export and piggybacked methanol import pipelines.</p>	<p>Option 1a: Leave in situ (minimum intervention).</p> <p>Disconnected ends stabilised with rock and the buried pipeline to remain in situ.</p>	<p>Pipelines and mattress were subject to a formal comparative assessment which concluded that in situ decommissioning with minimum intervention was the preferred option. Rock-placement (max. 25Te per cut pipeline end) on the cut pipeline ends only.</p> <p>The results for leave in-situ were more attractive for all criteria compared to the full removal options. The pipelines in this group are buried and therefore do not present a snagging risk. The technical challenge and cost for full removal of rigid pipelines and associated heightened safety risk exposure during full removal, the environmental impact from seabed disturbance during dredging activities to unbury the piggybacked pipelines prior to removal and the environmental impact of greater vessel usage to support full removal is considerably less attractive than the same criteria associated with leaving these buried pipelines in situ.</p>
<p>Group 3c: PL1091, PL1092</p> <p>Callisto ZM to Ganymede ZD gas export and piggybacked methanol import pipelines.</p>	<p>Option 1a: Leave in situ (minimum intervention).</p> <p>Disconnected ends stabilised with rock and the buried pipeline to remain in situ.</p>	<p>Pipelines and associated mattresses were subject to a formal comparative assessment which concluded that the leave in situ options (Option 1a - minimum intervention and Option 2a – minor intervention) and partial removal option (Option 4a) were equally preferred.</p> <p>The cost and technical challenge for full removal of concrete coated rigid pipelines and associated heightened safety risk exposure during full removal, the environmental impact from seabed disturbance during dredging activities to unbury ~14km of piggybacked pipelines prior to removal and the environmental impact of greater vessel usage to support full removal is less attractive than the same criteria associated with leaving these pipelines in situ, or removing spans by cut and lift or rock cover.</p> <p>Despite the overall results, and therefore preference, for leave in-situ being approximately similar to partial removal of spans by cut and lift and minor intervention by rock cover, the leave in-situ option was selected. This option required minor rock placement at pipeline ends only, whereas the partial removal option and the option requiring the placement of rock over spans both required significantly more rock in addition to the pipeline ends. Due to the greater habitat loss associated with the additional rock placement in the protected area for these options, the leave in-situ option was chosen.</p>

Table 3.6: Outcomes of Comparative Assessment

Pipeline or Group	Recommended Option*	Justification
		<p>Inspection data of the Callisto ZM and Ganymede ZD pipelines (PL1091 and PL1092) were analysed to identify the magnitude of the risk exposure to the other users of the sea associated with the presence of pipeline exposure for the leave in-situ option chosen.</p> <p>Analysis confirmed that the pipelines were predominantly buried, there was pipeline exposure by no infield spanning and where exposure was present it was isolated and variable over time in terms of length and location and did not pose a snagging risk.</p> <p>These piggybacked pipelines will therefore remain in situ with minimum intervention and rock will be placed (max. 25Te per cut pipeline end) on the cut pipeline ends only.</p>
<p>Group 4: PL1093, PL1094</p> <p>Ganymede ZD to LOGGS PR gas export and piggybacked methanol import pipelines.</p>	<p>Option 1a: Leave in situ (minimum intervention).</p> <p>Disconnected ends stabilised with rock and the buried pipeline to remain in situ.</p>	<p>Pipelines and associated mattresses were subject to a formal comparative assessment which concluded that the leave in situ options (Option 1a - minimum intervention and Option 2a – minor intervention) and partial removal option (Option 4a) were equally preferred.</p> <p>The cost and technical challenge for full removal of large diameter concrete coated rigid pipelines and associated heightened safety risk exposure during full removal, the environmental impact from seabed disturbance during dredging activities to unbury ~20km of piggybacked pipelines prior to removal and the environmental impact of greater vessel usage to support full removal is less attractive than the same criteria associated with leaving these pipelines in situ, or removing spans by cut and lift or rock cover.</p> <p>Despite the overall results, and therefore preference, for leave in-situ being approximately similar to partial removal of spans by cut and lift and minor intervention by rock cover, the leave in-situ option was selected. This option required minor rock placement at pipeline ends only, whereas the partial removal option and the option requiring the placement of rock over spans both required significantly more rock in addition to the pipeline ends. Due to the greater habitat loss associated with the additional rock placement in the protected area for these options, the leave in-situ option was chosen.</p>

Table 3.6: Outcomes of Comparative Assessment

Pipeline or Group	Recommended Option*	Justification
		<p>Inspection data of the Ganymede ZD to LOGGS PR pipelines (PL1093 and PL1094) were analysed to identify the magnitude of the risk exposure to the other users of the sea associated with the presence of pipeline exposure for the leave in-situ option chosen</p> <p>Analysis confirmed that the pipelines were predominantly buried, there was pipeline exposure by no infield spanning and where exposure was present it was isolated and variable over time in terms of length and location and did not pose a snagging risk.</p> <p>These piggybacked pipelines will therefore remain in situ with minimum intervention and rock will be placed (max. 25Te per cut pipeline end) on the cut pipeline ends only.</p>
<p>Group 7: PLU4178 (UM2)</p> <p>Ganymede ZD to Callisto ZM umbilical</p>	<p>Option 4a: Partial Removal</p> <p>Disconnected ends stabilised with rock and the buried pipeline to remain in situ.</p> <p>The single persistent midline exposure will be removed by cut and lift operations and the cut ends will be back filled.</p>	<p>Pipelines and associated mattresses were subject to a formal comparative assessment which concluded that the leave in situ options (Option 1a - minimum intervention and Option 2a – minor intervention) and partial removal option (Option 4a) were equally preferred.</p> <p>The technical challenge for full removal of 14km umbilical and associated heightened safety risk exposure during reverse reeling, the environmental impact from seabed disturbance during dredging activities to unbury the umbilical prior to removal and the environmental impact of greater vessel usage to support full removal is less attractive than the same criteria associated with leaving these pipelines in situ, or removing spans by cut and lift or rock cover</p> <p>Further analysis of the umbilical (PLU4178) inspection results identified a single exposure of approximately 11m in length. The exposure was not spanning and did not pose a snagging risk to other users of the sea. However, owing to the persistent nature of the exposed section and the potential to dredge and remove the exposure without introducing rock (hence no habitat loss from remediation), the partial removal option was chosen. The exposed section will be removed leaving the remaining pipeline buried.</p> <p>Survey to be undertaken following remediation (timing to be discussed and agreed with OPRED) to confirm the burial status of the cut umbilical ends.</p>

Table 3.6: Outcomes of Comparative Assessment		
Pipeline or Group	Recommended Option*	Justification
Subsea Tee and Pigging Skid Junction between Europa EZ and ZD-ZM pipeline.	Full Removal	Subsea tee and associated pigging skid were not subject to the CA process following OPRED guidance for a clear seabed. The subsea tee and pigging skid are therefore to be removed to shore.

* Key to Options:

- 1a) Leave in situ (minimum intervention to stabilise pipeline ends only)
- 2a) Leave in situ (minor intervention with rock cover over exposures)
- 4a) Partial removal (removal of exposures)
- 5a) Full removal (reverse reel)
- 6a) Full removal (cut and lift)

Chrysaor have risk assessed and understand the risk and consequences of decommissioning pipelines in situ.

3.5 Pipeline Stabilisation Features

All pipeline stabilisation features were subject to a formal comparative assessment as part of the pipelines under consideration. Pipeline stabilisation features are to remain in situ to stabilise the pipelines that remain in situ. Where pipelines are to be removed, the associated stabilisation features will also be removed where safe to do so.

Table 3.7 Pipeline Stabilisation Features				
Pipeline or Group	Stabilisation features	Number	Option	Disposal Route
Group 2: PL1690, PL1691, PLU4177 (UM3) 80m sections between the Callisto ZM and NW Bell subsea manifolds.	Concrete mattresses	39	Pipelines and stabilisation features were subject to a formal comparative assessment which concluded that full removal of the short 80m pipelines by cut and lift and associated mattresses was the preferred option.	Onshore disposal
	Grout bags	2	Pipelines and stabilisation features were subject to a formal comparative assessment which concluded that full removal of the short 80m pipelines by cut and lift and associated grout bags was the preferred option.	Onshore disposal
	Formwork	None	N/A	N/A

Table 3.7 Pipeline Stabilisation Features				
Pipeline or Group	Stabilisation features	Number	Option	Disposal Route
	FronD mats	19	Pipelines and stabilisation features were subject to a formal comparative assessment which concluded that full removal of the short 80m pipelines by cut and lift and associated mattresses was the preferred option.	Onshore disposal
	Rock dump	6m length	Decommissioning in situ because full removal without large scale disturbance to the seabed is impractical.	N/A
	Other			
Group 3a: PL1694, PL1695 Europa EZ to ZM-ZD tee gas export and piggybacked methanol import pipelines.	Concrete mattresses	15	Pipelines and stabilisation features were subject to a formal comparative assessment which concluded that in situ decommissioning with minimum intervention was the preferred option.	None required*
	Grout bags	0	N/A	N/A
	Formwork	None	N/A	N/A
	FronD mats	28	Pipelines and stabilisation features were subject to a formal comparative assessment which concluded that in situ decommissioning with minimum intervention was the preferred option.	None required*
	Rock dump	306m length	Pipelines and stabilisation features were subject to a formal comparative assessment which concluded that in situ decommissioning with minimum intervention was the preferred option.	None required*
	Other			

Table 3.7 Pipeline Stabilisation Features				
Pipeline or Group	Stabilisation features	Number	Option	Disposal Route
Group 3c: PL1091, PL1092 Callisto ZM to Ganymede ZD gas export and piggybacked methanol import pipelines.	Concrete mattresses	31	Pipelines and stabilisation features were subject to a formal comparative assessment which concluded that in situ decommissioning with minimum intervention was the preferred option.	None required*
	Grout bags	0	N/A	N/A
	Formwork	None	N/A	N/A
	Froned mats	8	Pipelines and stabilisation features were subject to a formal comparative assessment which concluded that in situ decommissioning with minimum intervention was the preferred option.	None required*
	Rock dump	964m length	Pipelines and stabilisation features were subject to a formal comparative assessment which concluded that in situ decommissioning with minimum intervention was the preferred option.	None required*
	Other: Debris	Protective structure	In 2011 a protective structure was identified during an inspection structure at KP7.9. This is thought to be from the tee piece tie-in of the Sinope Platform. If identified in the debris clearance campaign, it will be removed.	Onshore disposal

Table 3.7 Pipeline Stabilisation Features				
Pipeline or Group	Stabilisation features	Number	Option	Disposal Route
Group 4: PL1093, PL1094 Ganymede ZD to LOGGS PR gas export and piggybacked methanol import pipelines.	Concrete mattresses	4	Pipelines and stabilisation features were subject to a formal comparative assessment which concluded that in situ decommissioning with minimum intervention was the preferred option.	None required*
	Grout bags	1	Pipelines and stabilisation features were subject to a formal comparative assessment which concluded that in situ decommissioning with minimum intervention was the preferred option.	None required*
	Formwork	None	N/A	N/A
	Froned mats	None	N/A	N/A
	Rock dump	594m length	Pipelines and stabilisation features were subject to a formal comparative assessment which concluded that in situ decommissioning with minimum intervention was the preferred option.	None required*
	Other: Debris	Scaffold Pole	To be removed, if found.	Onshore disposal

Table 3.7 Pipeline Stabilisation Features				
Pipeline or Group	Stabilisation features	Number	Option	Disposal Route
PLU4178 (UM2) Ganymede ZD to Callisto ZM umbilical	Concrete mattresses	8	Umbilical and stabilisation features were subject to a formal comparative assessment which concluded that partial removal of the exposure mid pipeline was the preferred option. The rest of the umbilical is buried and the pipeline and associated mattresses will remain in situ.	None required*
	Grout bags	None	N/A	N/A
	Formwork	None	N/A	N/A
	Froned mats	1	Umbilical and stabilisation features were subject to a formal comparative assessment which concluded that partial removal of the exposure mid pipeline was the preferred option. The rest of the umbilical is buried and the pipeline and associated mattresses will remain in situ.	None required*
	Rock dump	2m	Umbilical and stabilisation features were subject to a formal comparative assessment which concluded that partial removal of the exposure mid pipeline was the preferred option. The rest of the umbilical is buried and the pipeline and associated rock will remain in situ.	None required*
	Other: Debris	Plastic Object	All debris to be removed	Onshore disposal

*Note** Leave in situ

3.6 Wells

Table 3.8: Well Plug and Abandonment

The Ganymede ZD and Europa EZ platform wells (including the Sinope well on Europa EZ) have been plugged and abandoned using a Mobile Offshore Drilling Rig.

The Callisto ZM and NW Bell ZX subsea wells will be plugged and abandoned as part of a subsea well P&A programme in the SNS.

Master Application Templates (MATs) and the supporting Subsidiary Application Templates (SATs) have been submitted in support of all well plug and abandonment activities.

3.7 Drill Cuttings

3.7.1 Drill Cuttings Decommissioning Options

Not applicable. No drill cuttings have been identified on the seabed adjacent to the installations in subsea inspections conducted in 1994, 2000 and 2015. The dynamic marine environment has resulted in the redistribution of drill cuttings.

3.8 Waste Streams

Table 3.9 Waste Stream Management Methods

Waste Stream	Removal and Disposal method
Bulk liquids	Pipeline flushing fluids will be injected into redundant gas production wells. Bulk liquids removed from vessels and transported to shore. Vessels and pipework will be drained prior to removal to shore and shipped in accordance with maritime transportation guidelines. Bulk fluids taken onshore for handling at an appropriately permitted facility prior to onshore treatment and disposal.
Marine growth	To be taken onshore with the infrastructure identified for removal for handling at the appropriately permitted decontamination and disposal facility prior to onshore disposal via landfill or composting.
NORM	To be taken onshore with the infrastructure identified for removal and decontamination at the appropriately permitted decontamination and disposal facility prior to onshore disposal. NORM not removed as part of pipeline cleaning will be left in situ and is considered to have a negligible impact on the receiving marine environment (EA Section 5.19).
Asbestos	To be taken onshore with the infrastructure identified for removal for handling at the appropriately permitted decontamination and disposal facility prior to onshore disposal.
Other hazardous wastes	To be taken onshore with the infrastructure identified for removal for handling at the appropriately permitted decontamination and disposal facility prior to onshore disposal.
Onshore Dismantling sites	<p>Appropriately permitted sites have been selected through the Chrysaor procurement process.</p> <p>The decontamination and disposal facility selection considered the suitability of the facility, systems in place for the safe and efficient segregation and storage of waste in accordance with operational site permits, proven materials re-use and recycling performance including the use of innovative materials management practices to minimise the quantity of materials disposed of.</p> <p>All structures are to be consigned to the Veolia Petersons Outer Harbour Decommissioning Facility, Great Yarmouth, United Kingdom. Trans-frontier shipment of waste will not be required.</p>

Table 3.10 Inventory Disposition			
	Total Inventory Tonnage	Planned Tonnage to shore*	Planned Tonnage Decommissioned in situ
Installations	2999	2847	152 (Below Mudline)
Pipelines	15765	13	15752**
Subsea Tees	40	40	0
Mattresses	1140	384	756

Note

* Excludes 73Tc marine growth associated with the installation jackets and weight

** Conservative estimate: Includes the tonnage of the spool piece which will be removed between the platform and the touch down point on the seabed to provide clearance for the removal of the installations and the minor tonnage of the exposed 11m umbilical section removed from PLU4178 (UM2).

It is not currently possible to predict the market for re-usable materials with confidence however there is a target that >95% of the materials will be recycled.

In accordance with the Chrysaor Waste Management Standard, all facilities receiving waste are to be approved by the Company prior to use. Approval requires a favourable assessment of a waste facility’s ability to avoid environmental harm through protective designs, operations, monitoring, financial integrity and institutional controls. Post approval, the facility will be audited to confirm operations are undertaken within the conditions of associated site permits and to confirm its ongoing suitability for continued use and to identify opportunities for improvement.

Chrysaor will collaborate with the operator of the waste facility to communicate the proposed consignment of the waste to the local regulatory authority in accordance with the site permits.

4 Environmental Appraisal Overview

4.1 Environmental Sensitivities (Summary)

Table 4.1: Environmental Sensitivities	
Environmental Receptor	Main Features
Conservation interests	<p>Sites of Conservation Importance</p> <p>The LOGGS infrastructure included within the scope of the Decommissioning Programmes is located within two sites of conservation importance; the North Norfolk Sandbanks and Saturn Reef Special Area of Conservation (SAC) and the Southern North Sea SAC.</p> <p>The North Norfolk Sandbanks and Saturn Reef SAC site has been selected for designation due to the presence of the Annex I habitats: sandbanks which are slightly covered by water at all times and biogenic reef habitats formed by <i>Sabellaria spinulosa</i>. The Conservation Objectives for the North Norfolk Sandbanks and Saturn Reef SAC are for the features to be in favourable condition, thus ensuring site integrity in the long term and contribution to Favourable Conservation Status of Sandbanks and Reefs. This contribution would be achieved by maintaining or restoring, subject to natural change:</p> <ul style="list-style-type: none"> • The extent and distribution of the qualifying habitats in the site; • The structure and function of the qualifying habitats in the site; and • The supporting processes on which the qualifying habitats rely. <p>The Southern North Sea SAC has been identified as an area of importance for the Annex II species the harbour porpoise. This site includes key winter and summer habitat for this species. The Conservation Objectives of the site are to ensure that the integrity of the site is maintained and that it makes the best possible contribution to maintaining Favourable Conservation Status (FCS) for Harbour Porpoise in UK waters. In the context of natural change, this will be achieved by ensuring that:</p> <ul style="list-style-type: none"> • Harbour porpoise is a viable component of the site; • There is no significant disturbance of the species; and • The condition of supporting habitats and processes, and the availability of prey is maintained. <p>Annex II species likely to be sighted within the area of the proposed decommissioning activities include bottlenose dolphins, harbour porpoise, grey seals and common or harbour seals (EA Section 4.3).</p> <p>Marine Conservation Zones (MCZs)</p> <p>The installations and pipelines included within the scope of the decommissioning programmes do not transect any MCZs.</p>

Table 4.1: Environmental Sensitivities	
Environmental Receptor	Main Features
	<p>Special Protection Areas (SPAs) The installations and pipelines included within the scope of the decommissioning programmes do not transect any SPAs.</p>
Seabed	<p>The seabed in the vicinity of the LOGGS infrastructure is predominantly composed of sand with shells and shell fragments, with some gravel and cobbles. Sediments are generally well sorted and uniform.</p> <p>The Bathymetry across the area is relatively flat with mega-ripples and sand formations (EA Section 4.1).</p> <p>There is no evidence of bedrock, pockmarks or unusual or irregular bedforms.</p> <p>The infaunal community is generally dominated by crustacea and polychaete worms. The species are typical of the sandy sediments of southern North Sea.</p> <p>Whilst epifauna are generally sparse across the area due to the lack of hard substrata, polychaete worms, hermit crabs, fish including sand eels and flatfish, starfish including the common starfish and the sea star, and the soft coral dead mans' fingers are all observed.</p> <p>In terms of habitat classification, most stations within the associated pre-decommissioning baseline survey were categorised as 'infralittoral fine sand', which corresponds to clean sands occurring in shallow water (generally shallower than 20 m), either on open coast or in tideswept channels of marine inlets. This is consistent with the protected Annex I habitat 'sandbanks slightly covered by seawater all the time'.</p> <p>There is a high probability of <i>Sabellaria spinulosa</i> across the region. A small fragment of tube structure recovered in a sieve during sampling at the Ganymede ZD location was considered to have possibly been made by the Ross worm <i>Sabellaria spinulosa</i> aggregations of such tubes can sometimes create reef structures which are of conservation concern. However, no <i>Sabellaria spinulosa</i> were evident either as individuals or as tube aggregations from the survey, and none of the geophysical data suggested the presence of such structures. Seabed imagery did not provide any evidence of any threatened and/or declining species and habitats on the OSPAR (2008) list or any species on the International Union for Conservation of Nature Global Red List of threatened species (Gardline, 2015).</p>
Fish	<p>The area is located within the spawning grounds of cod (January to April, [peak spawning February to March]), lemon sole (April to September), Norway lobster (January 20 December [peak spawning April to June]), plaice (December to March [peak spawning January to February]), sandeels (November to February), sole (December and March to May [peak spawning in April]), sprat (May to August [peak spawning May to June]), thornback ray (February to September [peak spawning April to August]) and whiting (February to June).</p> <p>Within the decommissioning area is an area of high intensity spawning for plaice.</p>

Table 4.1: Environmental Sensitivities	
Environmental Receptor	Main Features
	<p>The following species have nursery grounds in the vicinity of the project: anglerfish, cod, herring, lemon sole, plaice, sandeel, sprat, mackerel, spurdog, herring, Norway lobster, sole, tope, thornback ray and whiting.</p> <p>Within the decommissioning area is an area of high intensity nursery grounds for cod, herring and whiting.</p>
Fisheries	<p>Across wider LOGGS Area (North and South), fishing grounds are fished at varying degrees by the following fleets (Chrysaor, 2017b):</p> <ul style="list-style-type: none"> • Dutch beam trawlers, demersal otter trawlers, and fly seiners; • UK potters, shrimp beam trawlers, shellfish dredgers, otter trawlers, long-liners, and netters; • Belgian beam trawlers and demersal otter trawlers; • Danish sandeelers, midwater and demersal trawlers and seine netters; • Norwegian purse seiners and midwater otter trawlers; • German beam trawlers and demersal otter trawlers; • French otter trawlers (demersal and pelagic); and • French purse seine netters. <p>The main species targeted are shellfish, with demersal species dominate catch in some areas. The highest number of effort days takes place in the summer months (July-September). Activity is low to moderate except at the Europa platform where fishing intensity is higher (EA Section 4.5).</p>
Marine Mammals	<p>Cetaceans regularly recorded in the North Sea include the harbour porpoise, bottlenose dolphin, minke whale, killer whale, Atlantic white-sided dolphin and white-beaked dolphin. Rarer species that are occasionally observed in the North Sea include fin whale, long-finned pilot whale, Risso’s dolphin and the short beaked common dolphin. However, harbour porpoise and white-beaked dolphin are the only cetaceans considered as regular visitors in the Southern North Sea throughout most of the year, and minke whale as a frequent seasonal visitor (EA Section 4.3.1).</p> <p>Pinnipeds sighted in the area include grey seals, and harbour seals. Grey seals may travel past the infrastructure towards foraging grounds, but densities generally reduce with distance offshore. Harbour seals are more likely to be sighted further offshore, travelling to this area from breeding and haul out sites in The Wash to forage for food (EA Section 4.3.2).</p>
Birds	<p>The most common species of seabird found in these areas of the SNS include fulmar, gannet, guillemot, kittiwake, razorbill, puffin and little auk, as well as numerous species of gull, tern and skua.</p> <p>In the decommissioning area the sensitivity of seabirds to oil pollution, reflected by the Seabird Oil Sensitivity Index, is low between July and September.</p>

Table 4.1: Environmental Sensitivities	
Environmental Receptor	Main Features
	Between November and March, the Seabird Oil Sensitivity Index is very high to extremely high. There is no data for April to June for many of the blocks, and again for October and November.
Onshore Communities	An onshore decontamination and dismantlement facility will be used that is deemed able to comply with all relevant permitting and legislative requirements.
Other Users of the Sea	<p>Shipping Shipping density in the area of the infrastructure to be decommissioned ranges from very low to high. The main contributing factor of very high vessel density in the area closer to shore is the number of large international ports within the region including Hull, Immingham, Grimsby and Great Yarmouth (EA Section 4.7).</p> <p>Oil & Gas Industry The infrastructure is located in the SNS gas basin which is densely populated by various installations. See table 1.6, figure 1.3 and figure 1.4 for information regarding adjacent facilities.</p> <p>Offshore Renewables The nearest windfarms are Hornsea zone and East Anglia zone located approximately 35 km SE from LOGGS facilities, and the Dundgeon windfarm site which is located approximately 36 km W.</p>
Atmosphere	Atmospheric emissions during decommissioning activities will occur in the context of the cessation of production. As such, almost all future emissions (from Project operations and vessels) will cease (EA Section 3.1).

4.2 Potential Environmental Impacts and their Management

4.2.1 Environmental Impact Assessment Summary

The potential environmental impacts associated with the decommissioning activities have been assessed and it is concluded that the proposed decommissioning of the infrastructure can be completed without causing significant adverse impact to the environment. The results of the Environmental Impact Assessment (EIA) are presented in an Environmental Appraisal (EA) accompanying the Decommissioning Programmes.

The EA makes an assessment of the potential environmental impacts by identifying interactions between the proposed decommissioning activities and the associated environmental receptors. The EA also describes the proposed mitigation measures designed to avoid or reduce the identified potential environmental impacts and how these will be managed in accordance with Chrysaor’s Environmental Management System (EMS) while considering responses from stakeholders.

Table 4.2: Environmental Impact Management		
Activity	Main Impacts	Management
Topsides Removal	Energy use and atmospheric emissions (EA Section 3.1)	All engines, generators and combustion plant on the vessels will be well maintained and correctly operated to ensure that they are working efficiently to minimise energy use and gaseous emissions. Vessel operations will be minimised where practical.
	Underwater noise (EA Section 5.3)	A noise assessment has been completed to determine the likely impact of noise generated by the proposed operations on marine mammals in the surrounding area. The results of the assessment will be used during the planning of vessel operations.
	Accidental hydrocarbon release (EA Section 3.1)	Hydrocarbon inventories are to be removed from the topsides prior to commencing removal operations. The SNS Oil Pollution Emergency Plan has been updated in agreement with OPRED to include all planned decommissioning operations.

Table 4.2: Environmental Impact Management

Activity	Main Impacts	Management
Jacket Removal	Energy use and atmospheric emissions (EA Section 3.1)	<p>All engines, generators and combustion plant on the vessels will be well maintained and correctly operated to ensure that they are working efficiently to minimise energy use and gaseous emissions.</p> <p>Vessel operations will be minimised where practical.</p>
	Underwater noise (EA Section 5.3)	<p>A noise assessment has been completed to determine the likely impact of noise generated by the proposed operations on marine mammals in the surrounding area. The results of the assessment will be used during the planning of vessel operations.</p> <p>There is no intention to use underwater explosives during these activities. During well abandonment operations, there may be a requirement to use either a tubing conveyed perforating gun or jet (explosive) cutter during cutting and perforating operations on the wells.</p>
	Accidental hydrocarbon release (EA Section 3.1)	<p>The SNS Oil Pollution Emergency Plan has been updated in agreement with OPRED to include all planned decommissioning operations.</p>
	Seabed disturbance and loss of habitat (EA Section 5.1)	<p>The decommissioning operations will be carefully designed and executed to minimise the area of seabed that will be disturbed.</p> <p>Loss of habitat through the introduction of new material to the marine environment is to be avoided or minimised throughout the proposed operations.</p>

Table 4.2: Environmental Impact Management

Activity	Main Impacts	Management
Subsea Installation Removal	Energy use and atmospheric emissions (EA Section 3.1)	<p>All engines, generators and combustion plant on the vessels will be well maintained and correctly operated to ensure that they are working efficiently to minimise energy use and gaseous emissions.</p> <p>Vessel operations will be minimised where practical.</p>
	Underwater noise (EA Section 5.3)	<p>A noise assessment has been completed to determine the likely impact of noise generated by the proposed operations on marine mammals in the surrounding area. The results of the assessment will be used during the planning of vessel operations.</p> <p>There is no intention to use underwater explosives during these activities.</p>
	Accidental hydrocarbon release (EA Section 3.1)	<p>The SNS Oil Pollution Emergency Plan has been updated in agreement with OPRED to include all planned decommissioning operations as detailed within the Dismantlement Safety Case.</p>
	Seabed disturbance and loss of habitat (EA Section 5.1)	<p>The decommissioning operations will be carefully designed and executed to minimise the area of seabed that will be disturbed.</p> <p>Loss of habitat through the introduction of new material to the marine environment is to be avoided or minimised throughout the proposed operations.</p>
Decommissioning Pipelines	Energy use and atmospheric emissions (EA Section 3.1)	<p>All engines, generators and combustion plant on the vessels will be well maintained and correctly operated to ensure that they are</p>

Table 4.2: Environmental Impact Management

Activity	Main Impacts	Management
		working efficiently to minimise energy use and gaseous emissions.
	Underwater noise (EA Section 5.3)	A noise assessment has been completed to determine the likely impact of noise generated by the proposed operations on marine mammals in the surrounding area. The results of the assessment will be used during the planning of vessel operations.
	Seabed disturbance and loss of habitat (EA Section 5.1)	<p>The operations to remove the pipeline ends will be carefully designed and executed so as to minimise the area of seabed that will be disturbed.</p> <p>Loss of habitat through the introduction of new material to the marine environment is to be avoided or minimised throughout the proposed operations.</p> <p>The resulting rock berm profile will be overtrawlable.</p>
	Discharges to sea (EA Sections 3.1 and 5.1.4)	<p>The pipelines will be flushed prior to cutting of the pipeline ends.</p> <p>A chemical risk assessment will be undertaken and operations permitted under the Offshore Chemicals Regulations 2002 (as amended).</p> <p>Hydrocarbon discharges during subsea pipeline disconnect operations will be permitted under the Offshore Petroleum Activities (Oil Pollution Prevention and Control) Regulations 2005 (as amended).</p> <p>Residual hydrocarbons, scale and sediments will be released gradually after through-wall corrosion occurs and the integrity of the pipelines progressively fails. Through-wall degradation is</p>

Table 4.2: Environmental Impact Management		
Activity	Main Impacts	Management
		<p>anticipated to begin to occur after many decades (i.e. 60 – 100 years). Pathways from the pipelines to the receptors would be via the interstitial spaces in seabed sediments, overlying rock placement where applicable and the water column. Release would therefore be gradual and prolonged such that the effects on the receiving marine environment are negligible (EA Section 5.1.4).</p>
Decommissioning Stabilisation Features	Snagging hazard of stabilisation feature associated with pipeline (EA Section 5.1)	<p>Pipelines decommissioned in situ will continue to be shown on Navigational charts.</p> <p>Stabilisation features associated with pipeline remain in situ.</p> <p>Overtrawlability survey (or alternative survey non-intrusive techniques owing to the environmental sensitivities of the area) in the installation 500m zones where stabilisation features predominantly exist. No overtrawl activities will be undertaken along pipeline corridors or within sites designated to protect seabed features or habitats.</p> <p>Stabilisation features inherently overtrawlable by design.</p>
Decommissioning Drill Cuttings Piles	No drill cuttings piles present	No drill cuttings piles present.

Note: The verification of the seabed state within the Jupiter installations' 500m zones will be conducted at the time of decommissioning.

5 Interested Party Consultations

Note Section 5 to be populated post consultation.

Table 5.1 Summary of Stakeholder Comments		
Stakeholder	Comment	Response
Statutory Consultees (NFFO, SFF, NIFPO)	NFFO: The Federation would advise over trawl surveys where possible should be carried out to ascertain that the areas are free of snagging hazards post decommissioning.	Comments Noted
Statutory Consultees (GMS)	No comments received	N/A
Other (VisNed)	No comments received	N/A
Public	No comments received	N/A

6 Programme Management

6.1 Project Management and Verification

Chrysaor has established a UK Decommissioning organisation as a department to manage and execute decommissioning projects. Chrysaor's existing processes for Operations, Planning, Project Management, Procurement, Health Safety and Environment, will be used and tailored to meet the specific requirements of decommissioning projects. Chrysaor will manage all permitting, licences, authorisations, notices, consents and consultations.

Any changes to this decommissioning document will be discussed and agreed with OPRED.

6.2 Post-Decommissioning Debris Clearance and Verification

A post decommissioning debris survey will be carried out within all 500m safety zones. Discussions are underway with OPRED regarding the level of appropriate coverage for pipeline corridor survey along each existing pipeline and umbilical route. Oil and gas debris will be recovered for onshore disposal or recycling in line with existing disposal methods.

Verification of seabed state will be obtained. Whilst the worst-case seabed disturbance from overtrawl has been assessed, it is recognised that some of the decommissioning activities is occurring in the North Norfolk Sandbanks and Saturn Reef SAC, therefore different methods of determining debris clearance and snag risk may be required. The methods used will therefore be discussed and finalised with OPRED. This will be followed by a statement of clearance to all relevant governmental departments and statutory consultees.

Based on the findings from the Comparative Assessment the Decommission in situ – minimum intervention is the preferred pipeline decommissioning option for most of the pipelines in LDP3 apart from:

- PL1690, PL1691, PLU4177: the 80m pipeline lengths between Calisto ZM and NW Bell ZX where full removal is considered appropriate and
- PLU4178 where partial removal of the exposed section of umbilical is considered appropriate

The evaluation criteria which contributed to the conclusions were safety, environment and cost. The location of the installations and pipelines in the North Norfolk Sandbanks and Saturn Reef Special Area of Conservation (SAC) contributed to the scoring and results.

Where the chosen pipeline decommissioning methodology is to leave the pipelines in situ, rock will be placed on cut pipeline ends at the platforms and the subsea manifold and tee. The pipelines and mattresses are to be left in situ to minimise the disturbance to the established environment and reduce the requirements for the introduction of new material to the SAC. Where partial removal is the chosen pipeline decommissioning methodology, the cut ends of the remaining pipeline adjacent to the platform and subsea manifolds will be stabilised with rock and the adjacent sections to the remediated exposure will be back-filled in an attempt to minimise the requirement for rock placement on the cut ends.

Oil and gas debris activity and verification along the remaining pipeline corridor of the infield pipeline sections not subject to actual decommissioning works, will be carried out in accordance with OPRED guidance in operation at the time those activities commence. This activity will reflect the environmental setting of the North Norfolk Sandbanks and Saturn Reef Special Area of Conservation.

The outcomes of the overtrawl in the 500m zones and the alternative survey methods of the pipelines will be reported in the Close Out Report.

6.3 Schedule

Schedule of debris clearance activities and close out reporting to be agreed as part of the greater SNS-wide decommissioning campaign. Debris clearance to be undertaken in a suitable timeframe following installation removal. Post-removal surveys and close-out reporting to follow debris clearance of the 500m zones.

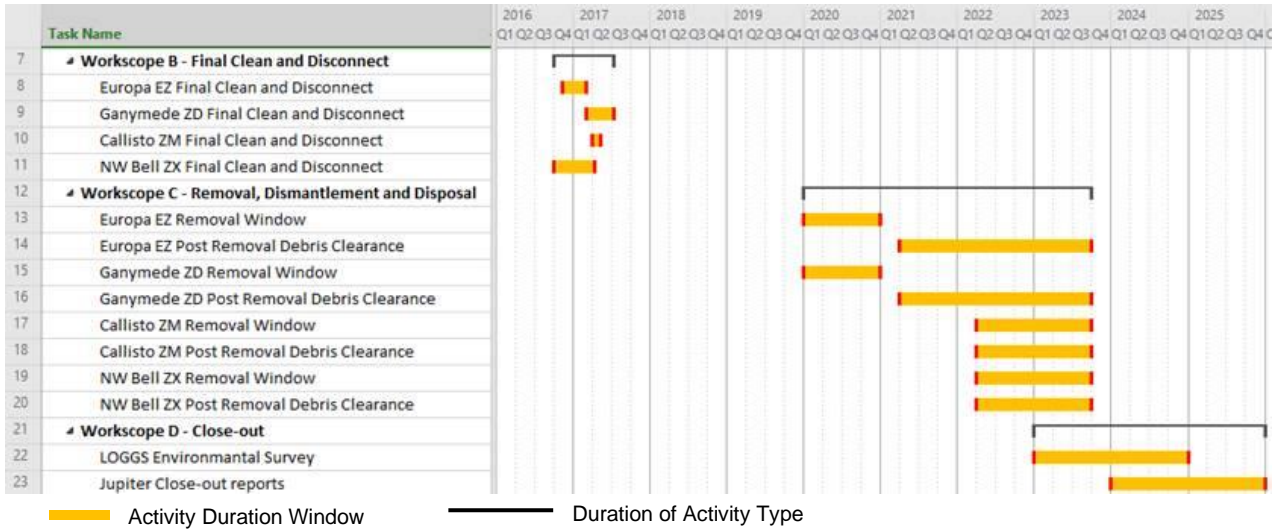

Note:

For the respective locations, debris clearance activity will follow removals, and environmental survey will follow debris clearance activity

This is an indicative schedule and is subject to change based on technical, market, and commercial, factors.

Figure 6.1: Gantt Chart of Project Plan

6.4 Costs

Table 6.1 – Provisional Decommissioning Programme costs*												
Asset Name	TOTAL	Operator Project Management	Facility Running / Owner Costs	Wells Abandonment	Facilities/ Pipeline Making Safe	Topside Preparation	Topside Removal	Sub-structure Jacket Removal	Topside and sub-structure Onshore Recycling	Subsea Infrastructure (pipelines, umbilicals, mattresses, SSIV)	Site Remediation	Monitoring
	£million	£million	£million	£million	£million	£million	£million	£million	£million	£million	£million	£million
Ganymede ZD Jacket												
Europa EZ												
Callisto ZM												
NW Bell ZX												
LDP3 Total												

Note: * An estimate of the overall cost has been provided separately to OPRED

Table 6.1: Decommissioning Costs

6.5 Close Out

In accordance with OPRED guidelines, a close out report covering the completion of the offshore decommissioning scope of this Decommissioning Programme will be submitted at time agreed by OPRED. The close out report will contain debris removal and verification of seabed clearance, the first post-decommissioning environmental survey and explanation of any variations to the approved Decommissioning Programmes.

6.6 Post Decommissioning Monitoring and Evaluation

A post decommissioning environmental seabed survey will be carried out once the offshore decommissioning work scope covered by this decommissioning document has been completed. The survey will include seabed sampling to monitor levels of hydrocarbons, heavy metals and other contaminants to allow for a comparison with the results of the pre-decommissioning survey.

Results of this survey will be available once the decommissioning document work scope is complete.

PIPELINE RISK BASED MONITORING PROGRAMME

All pipeline systems covered within this Decommissioning Document scope will be subject to survey. The post decommissioning pipeline (and associated stabilisation features) monitoring programme, to be agreed with OPRED, will:

- Begin with an initial baseline survey covering the full length of each pipeline;
- Be followed by a risk-based assessment for each pipeline (and associated stabilisation materials) which will inform the minimum agreed extent and frequency of future surveying. This will take account of pipeline burial, exposure and spanning data derived from the initial baseline survey, all available historical survey information and fisheries impact assessment;
- Provide a report of each required survey (with analysis of the findings, the impact on the risk-based assessment and identification of the proposed timing of the next survey in accordance with the agreed RBA approach), for discussion and agreement of OPRED;
- Include provision for remediation in the framework where such a requirement is identified. Appropriate remediation will be discussed and agreed with OPRED;
- Where remediation has been undertaken, a follow up survey of the remediated section(s) will be required;
- In the event of a reported snagging incident on any section of a pipeline, the requirement for any additional survey and/or remediation, will be discussed and agreed with OPRED;

- Will include a further fisheries impact assessment following completion of the agreed survey programme;
- Monitoring will become reactive following completion of the agreed survey programme and OPRED agreement of the analysis of the outcomes;
- Require pipeline information to be recorded on Navigation charts and FishSAFE.

The monitoring programme will also include discussion with OPRED of the long-term pipeline degradation and potential risk to other users of the sea following conclusion of the planned survey programme.

7 Supporting Documents

Document Number	Title
XOD-SNS-L-XX-X-HS-02-00005	Environmental Appraisal LOGGS Area Decommissioning (Decommissioning Programmes LDP2, LDP3, LDP4, LDP5)
XOD-SNS-L-XX-X-HS-02-00003	Comparative Assessment Report LOGGS Area Decommissioning (Decommissioning Programmes LDP2, LDP3, LDP4, LDP5)
J/1/20/2342	Fugro EMU Limited, 2013. Decommissioning Environmental Survey Report Viscount VO, Vulcan UR, and Vampire / Valkyrie OD (LOGGS)
J/1/20/2342-2	Fugro EMU Limited, 2013. Habitat Assessment Report Viscount VO, Vulcan UR, and Vampire / Valkyrie OD (LOGGS)
10553.2	Gardline Environmental Limited, 2015. Pre-decommissioning Survey Report LOGGS Gas Fields (LOGGS Hub, Mimas MN, Ganymede ZD, South Valiant TD and Europa EZ)
10553.2	Gardline Environmental Limited, 2015. Habitat Assessment Report LOGGS Gas Fields (LOGGS Hub, Mimas MN, Ganymede ZD, South Valiant TD and Europa EZ)
BMT-SNS-L-XX-P-HS-02-00001	Lincolnshire Offshore Gas Gathering System (LDP2, LDP3, LDP4 and LDP5) Pipeline Burial and Stabilisation Material Report

8 Partner Letters of Support

To:

Department for Business, Energy and Industrial Strategy (BEIS)
Offshore Petroleum Regulator for Environment & Decommissioning
AB1 Building
Crimon Place
Aberdeen
AB10 1BJ

Date: 20 May 2020

Dear Sir or Madam,

LOGGS Satellites Jupiter Area - Ganymede ZD Jacket, Europa EZ, Callisto ZM, NW Bell ZX and Associated Infield Pipelines Decommissioning Programmes: LDP3

PETROLEUM ACT 1998

We acknowledge receipt of your letter dated (18th May 2020).

We, Equinor UK Limited confirm that we hereby authorise Chrysaor Production (U.K.) Limited to submit on our behalf an abandonment programme relating to the Ganymede ZD Jacket, Europa EZ, Callisto ZM, NW Bell ZX and Associated Infield Pipelines Decommissioning Programmes, as directed by the Secretary of State on 18th May 2020.

We confirm that we support the proposals detailed in the LOGGS Satellites Jupiter Area - Ganymede ZD Jacket, Europa EZ, Callisto ZM, NW Bell ZX and Associated Infield Pipelines Decommissioning Programmes dated 19th May 2020, which is to be submitted by Chrysaor Production (U.K.) Limited in so far as they relate to those facilities in respect of which we are required to submit an abandonment programme under section 29 of the Petroleum Act 1998.

Yours faithfully,

(approved by email)

Nigel Gamblin
VP Asset Management

For and on behalf of Equinor UK Limited



Esso Exploration and Production UK Limited

Union Plaza
1 Union Wynd
Aberdeen
AB10 1SL

Telephone: +44 (0)1224 651914
Email: margaret.m.rogacki@exxonmobil.com

Margaret Rogacki
Asset Manager
Central/Northern North Sea

Department for Business, Energy and Industrial Strategy (BEIS)
Offshore Petroleum Regulator for Environment & Decommissioning
AB1 Building
Crimon Place
Aberdeen
AB10 1BJ

Date: 20th May 2020

Dear Sir or Madam,

LOGGS Satellites Jupiter Area - Ganymede ZD Jacket, Europa EZ, Callisto ZM, NW Bell ZX and Associated Infield Pipelines Decommissioning Programmes: LDP3

PETROLEUM ACT 1998

We acknowledge receipt of your letter dated (18th May 2020).

We, Esso Exploration and Production UK Limited, confirm that we hereby authorise Chrysaor Production (U.K.) Limited to submit on our behalf an abandonment programme relating to the Ganymede ZD Jacket, Europa EZ, Callisto ZM, NW Bell ZX and Associated Infield Pipelines Decommissioning Programmes, as directed by the Secretary of State on 18th May 2020.

We confirm that we support the proposals detailed in the LOGGS Satellites Jupiter Area - Ganymede ZD Jacket, Europa EZ, Callisto ZM, NW Bell ZX and Associated Infield Pipelines Decommissioning Programmes dated 19th May 2020, which is to be submitted by Chrysaor Production (U.K.) Limited in so far as they relate to those facilities in respect of which we are required to submit an abandonment programme under section 29 of the Petroleum Act 1998.

Yours faithfully,

DocuSigned by:

48B395534BB1477...

Margaret M. Rogacki
Asset Manager

For and on behalf of Esso Exploration and Production UK Limited

Registered in England
Number: 00207426
Registered Office:
Ermyn House, Ermyn Way
Leatherhead, Surrey KT22 8UX

9 Appendix 1 – Pipeline Burial Data

The pipeline burial data is contained within the Pipeline Burial Report for the LOGGS area and summarised for LDP3 below.

Pipeline PL1091 and Methanol Pipeline PL1092

Pipeline PL1091 is a 12" gas pipeline from the Callisto ZM structure to the Ganymede ZD platform, with a piggybacked 3" methanol (MeOH) pipeline PL1092. Both pipelines are approximately 14.3 km in length.

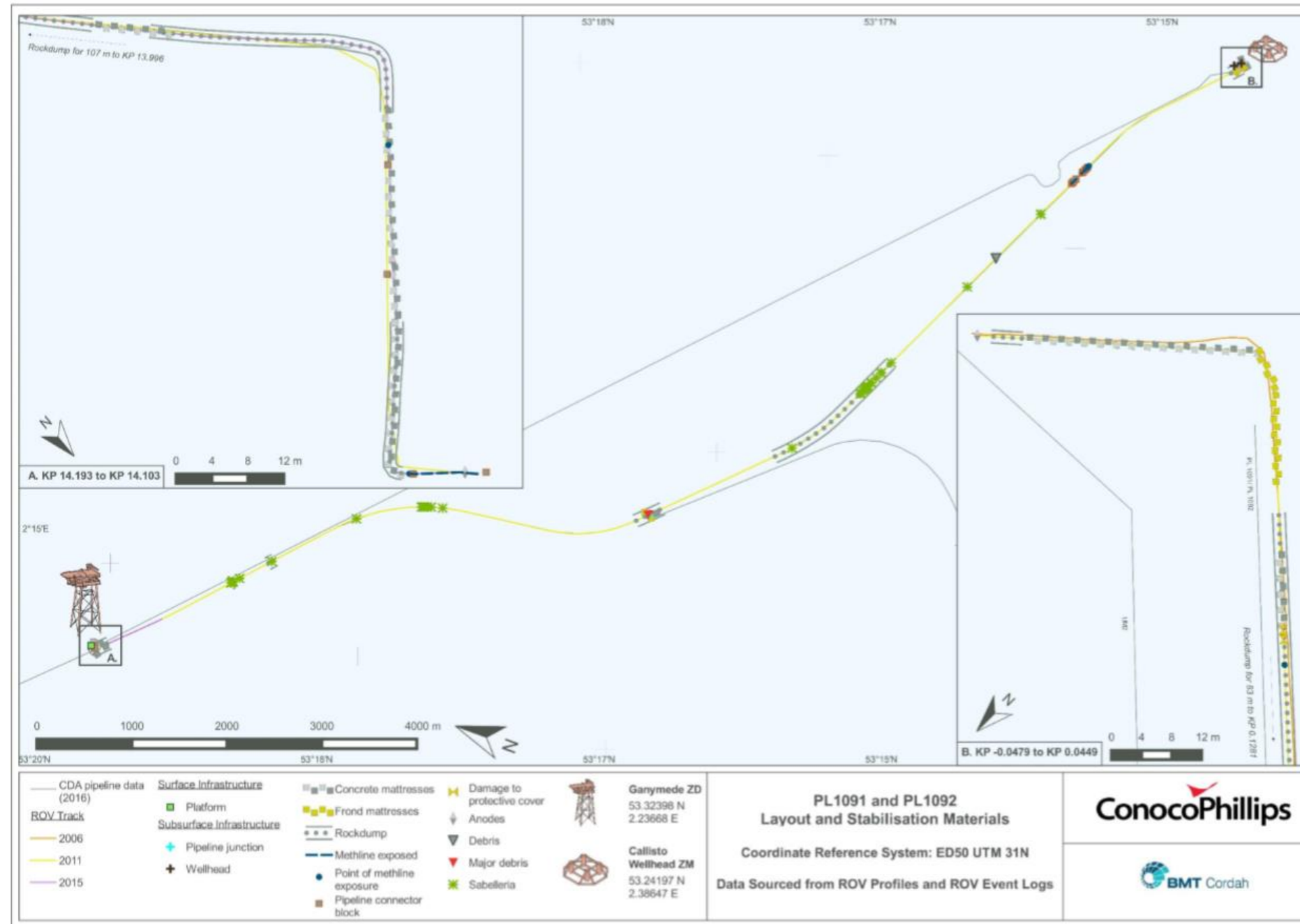

Schematic representation of the pipeline locations and associated features

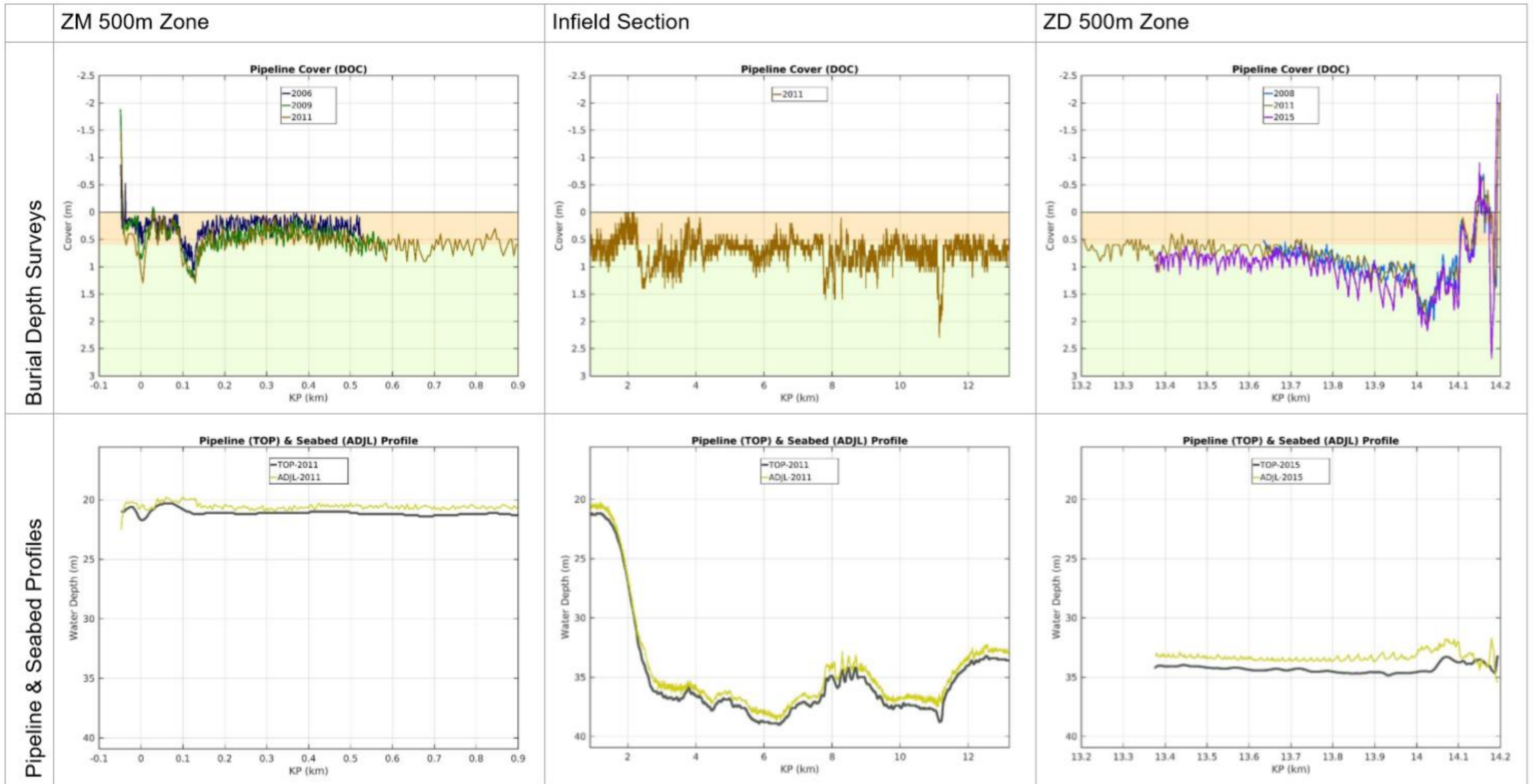

Note: ADJL = Adjacent seabed level at interface with pipeline (if pipeline buried or suspended then seabed level immediately above of beneath pipe respectively), DOC = Depth of Cover, TOP = Top of Pipe (depth to 12 o'clock position on the pipeline)

Pipeline depth of cover, top of pipe and seabed profiles

Pipeline PL1093 and Methanol Pipeline PL1094

Pipeline PL1093 is an 18" gas pipeline from the Ganymede ZD platform to the LOGGS PR platform, with a piggybacked 3" MeOH pipeline PL1094. Both pipelines are approximately 19.5 km in length.

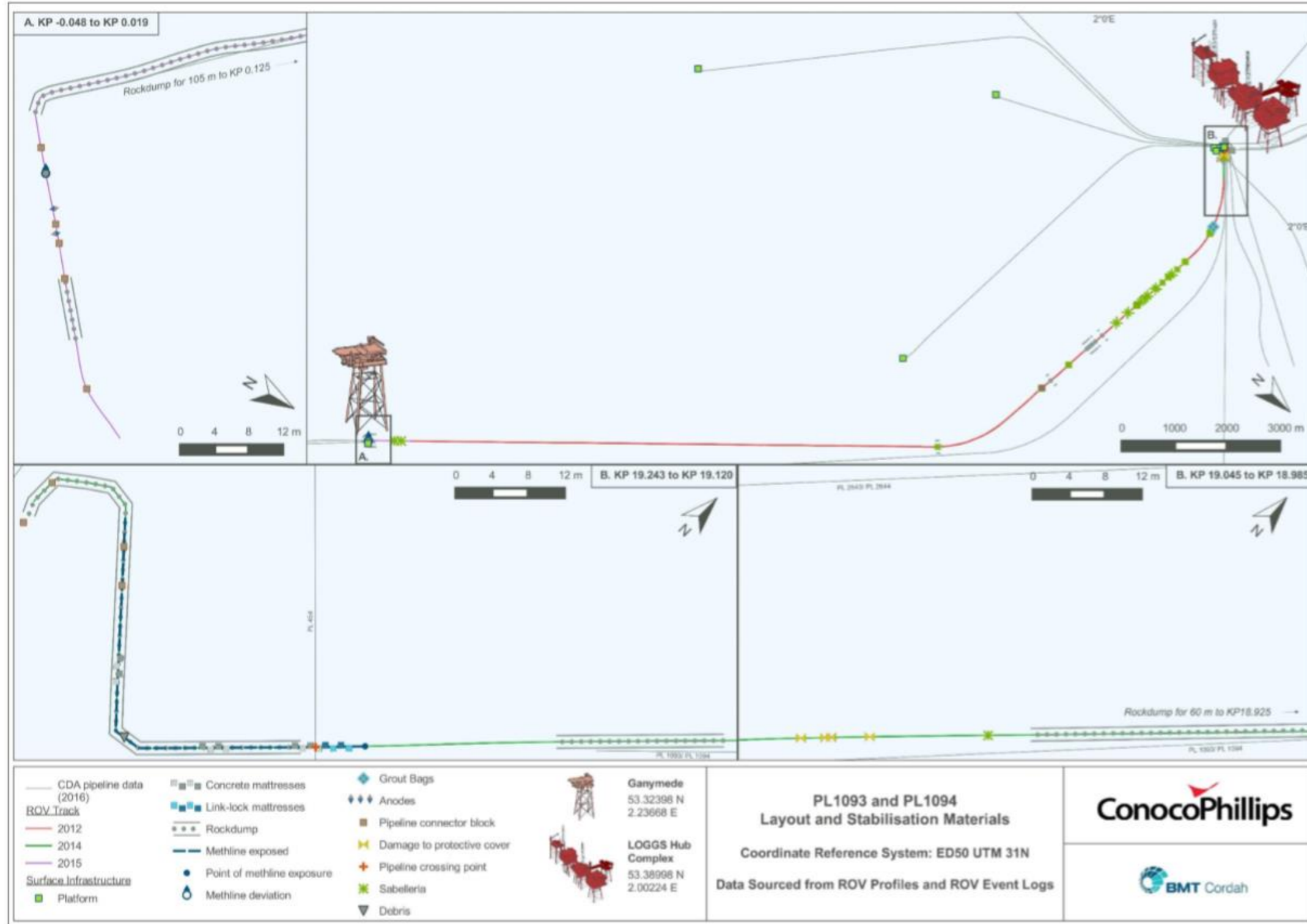

Schematic representation of the pipeline locations and associated features

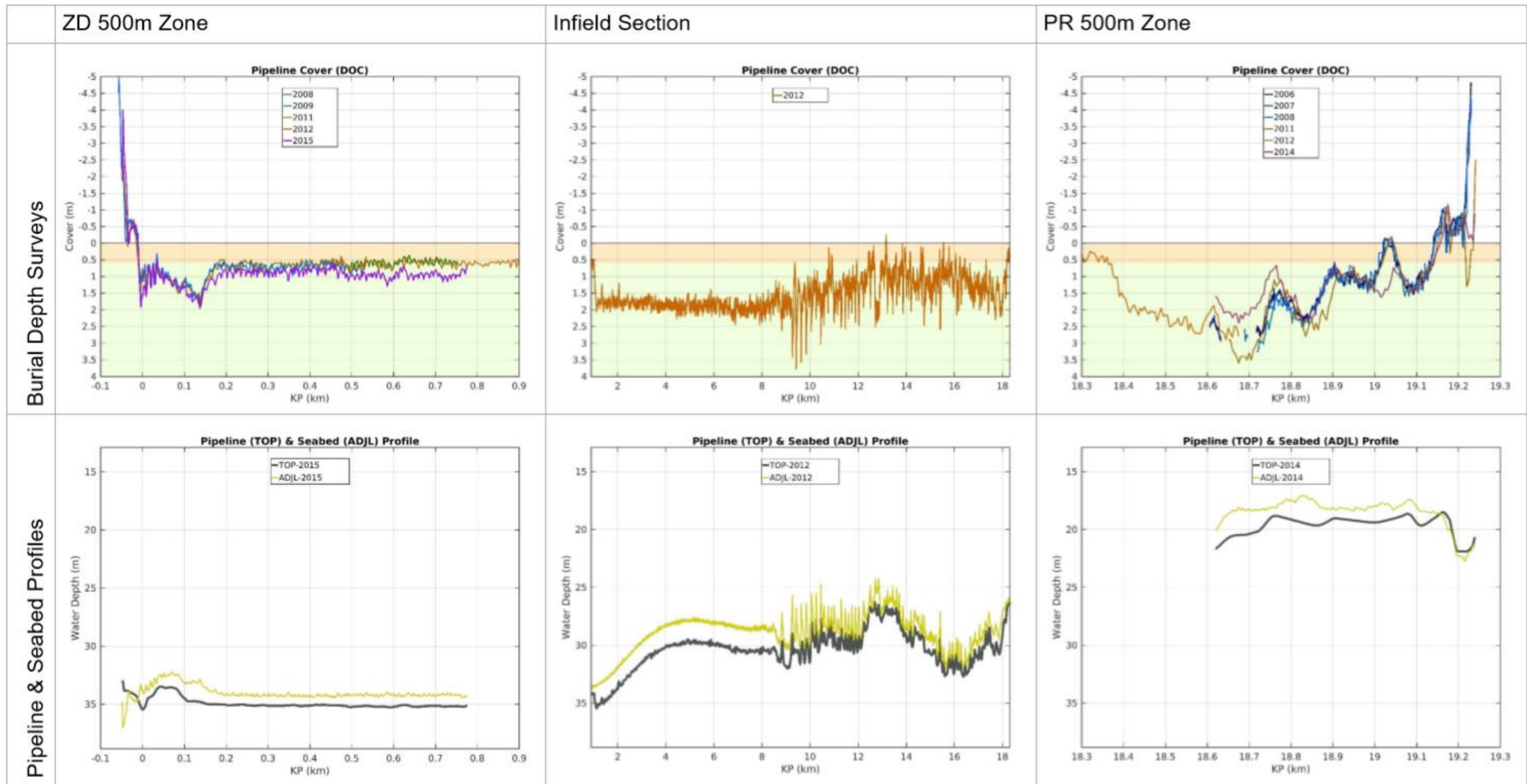

Note: ADJL = Adjacent seabed level at interface with pipeline (if pipeline buried or suspended then seabed level immediately above of beneath pipe respectively), DOC = Depth of Cover, TOP = Top of Pipe (depth to 12 o'clock position on the pipeline)

Pipeline depth of cover, top of pipe and seabed profiles

Pipeline PL1690 and Methanol Pipeline PL1691 Pipeline

PL1690 is an 8" gas pipeline from the NW Bell ZX structure to the Callisto ZM structure, with a piggybacked 3" MeOH pipeline PL1691. Both pipelines are approximately 0.08 km in length.

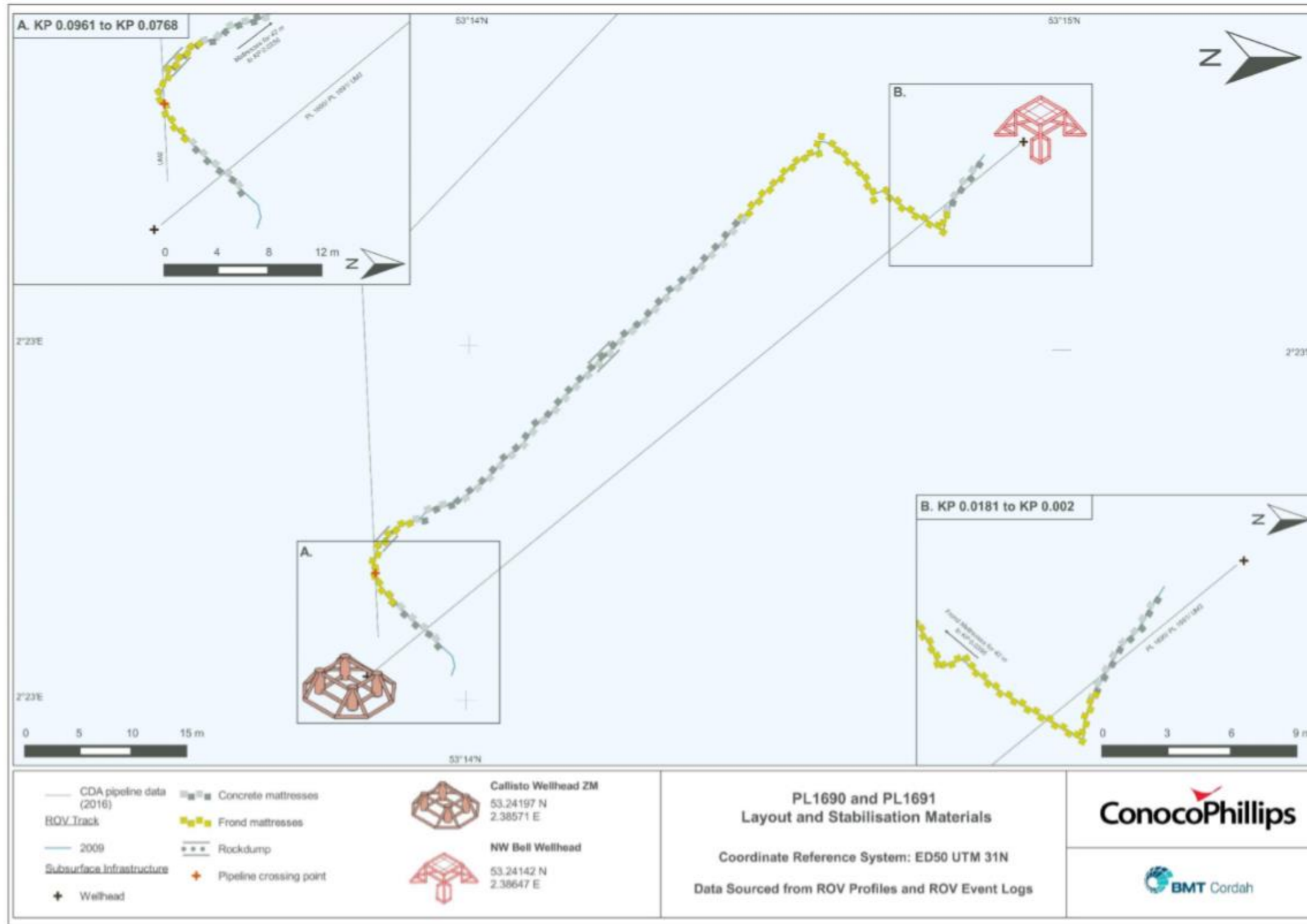

Schematic representation of the pipeline locations and associated features

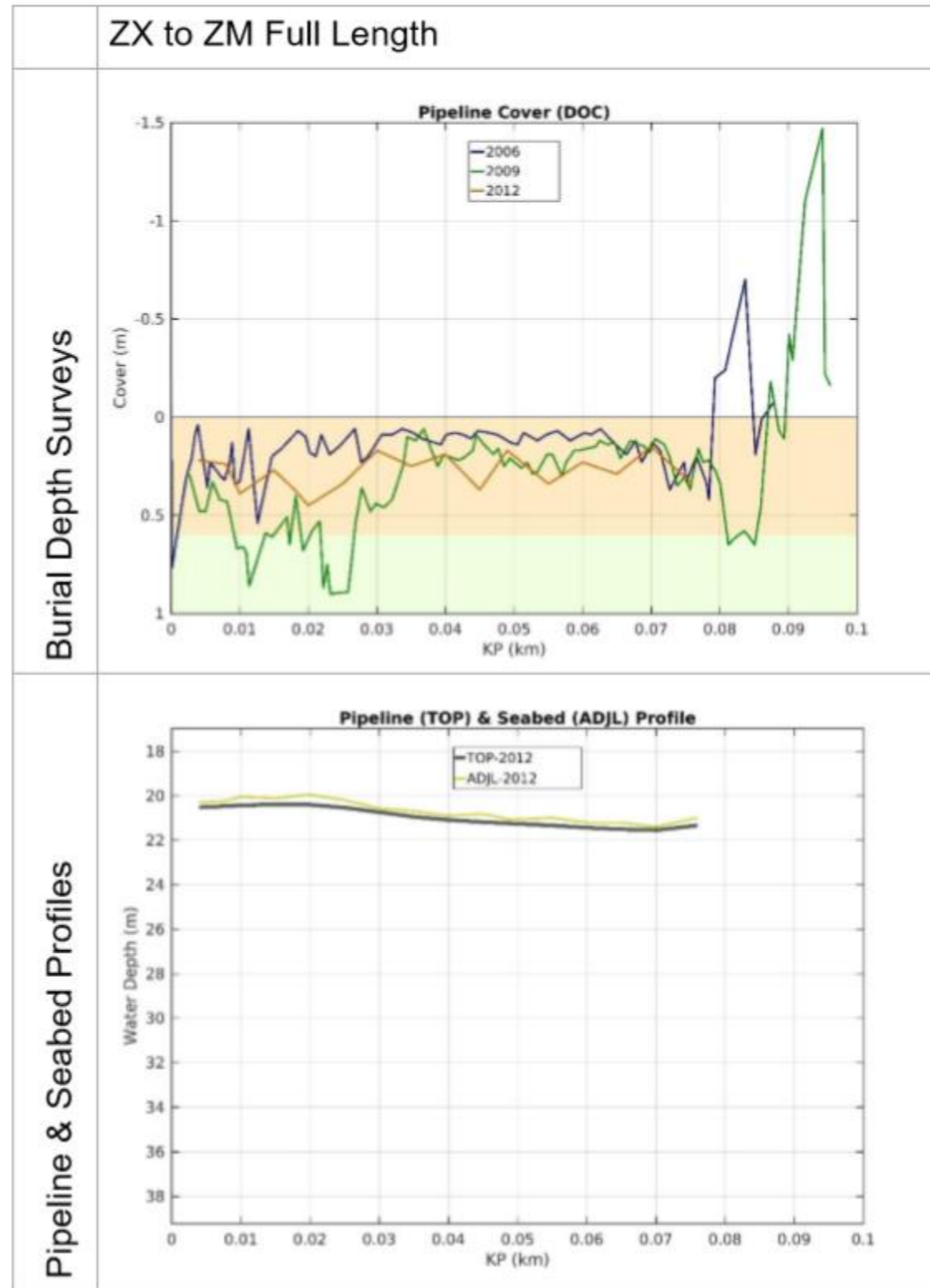

Note: ADJL = Adjacent seabed level at interface with pipeline (if pipeline buried or suspended then seabed level immediately above of beneath pipe respectively), DOC = Depth of Cover, TOP = Top of Pipe (depth to 12 o'clock position on the pipeline)

Pipeline depth of cover, top of pipe and seabed profile

Pipeline PL1694 and Methanol Pipeline PL1695 Pipeline

PL1694 is a 12" gas pipeline from the Europa EZ platform to the PL1091 tee, with a piggybacked 3" MeOH pipeline PL1695. Both pipelines are approximately 4.5 km in length.

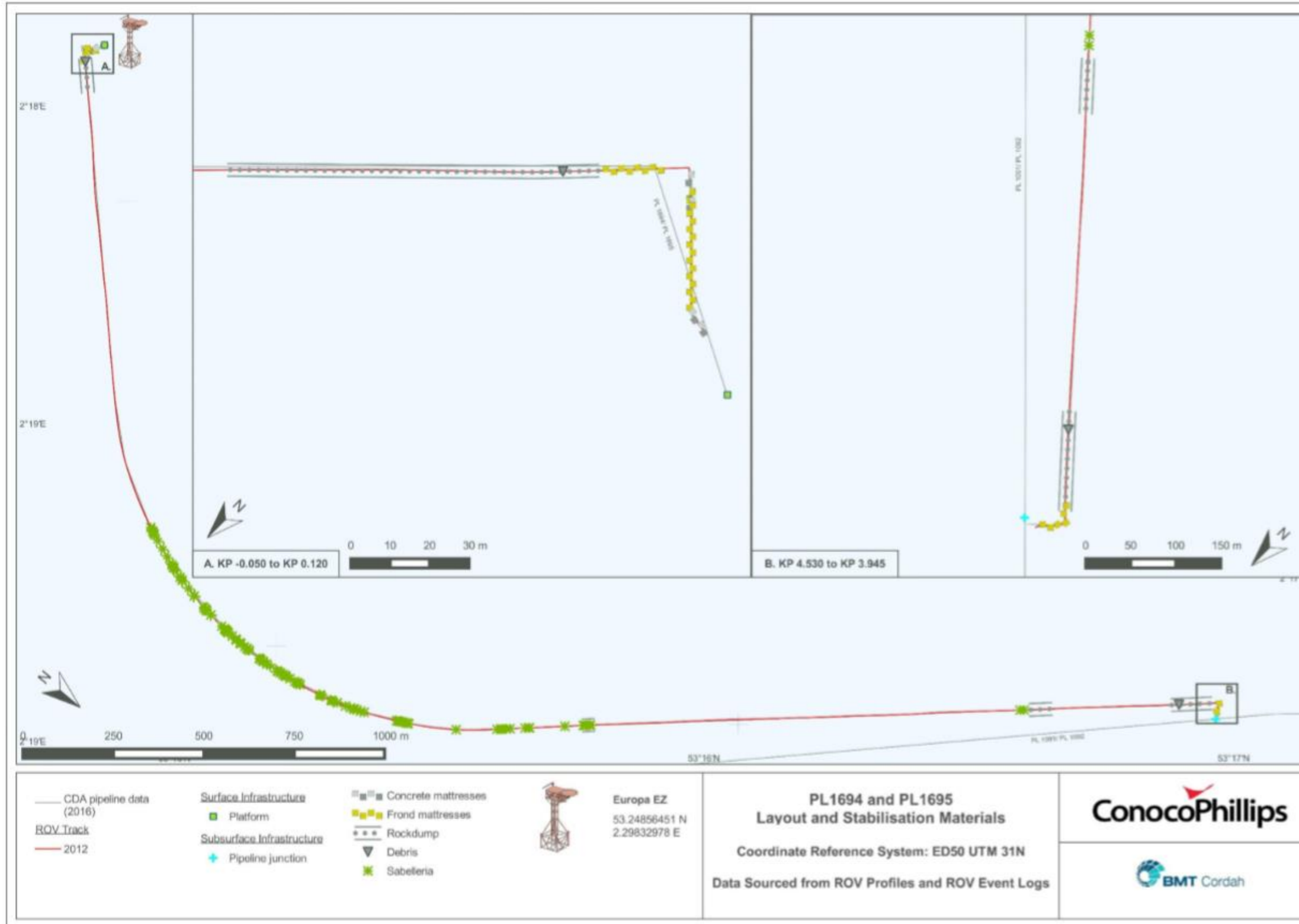

Schematic representation of the pipeline locations and associated features

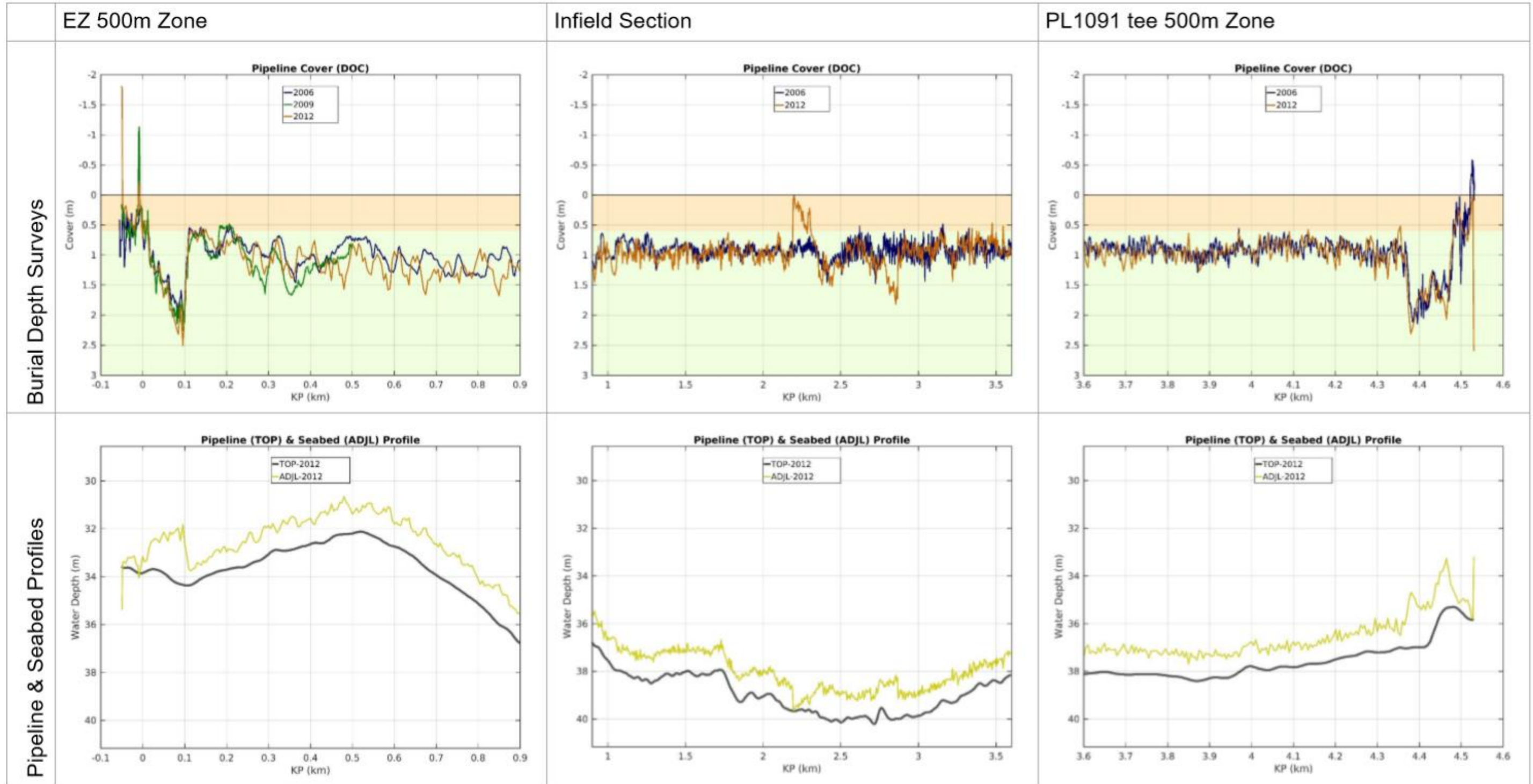

Note: ADJL = Adjacent seabed level at interface with pipeline (if pipeline buried or suspended then seabed level immediately above of beneath pipe respectively), DOC = Depth of Cover, TOP = Top of Pipe (depth to 12 o'clock position on the pipeline)

Pipeline depth of cover, top of pipe and seabed profiles

Umbilical PLU4178 (UM2)

Umbilical PLU4178 (UM2) is a 13.9 km 4" umbilical line from the Ganymede ZD platform to the Callisto ZM structure.

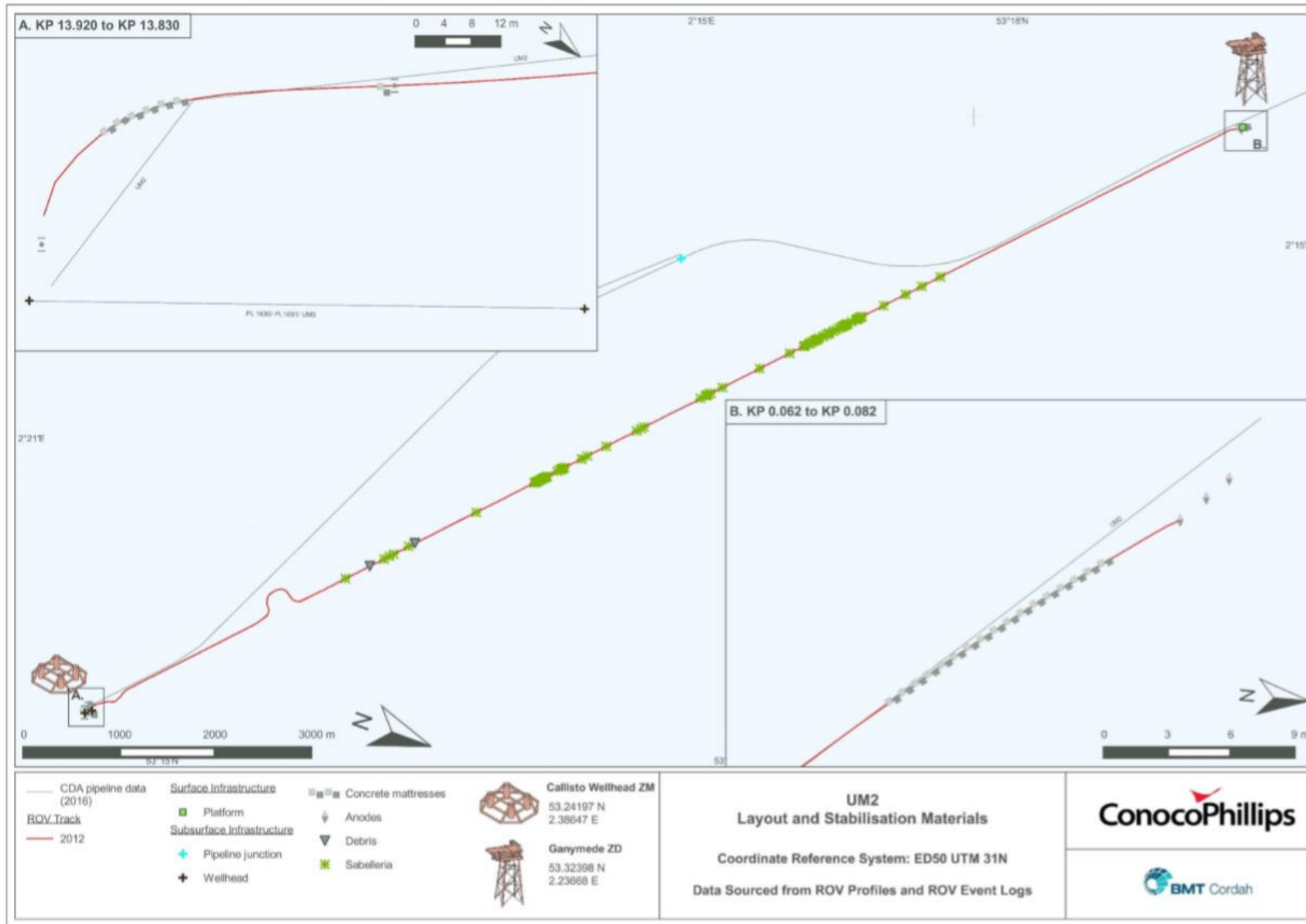

Schematic representation of the pipeline locations and associated features

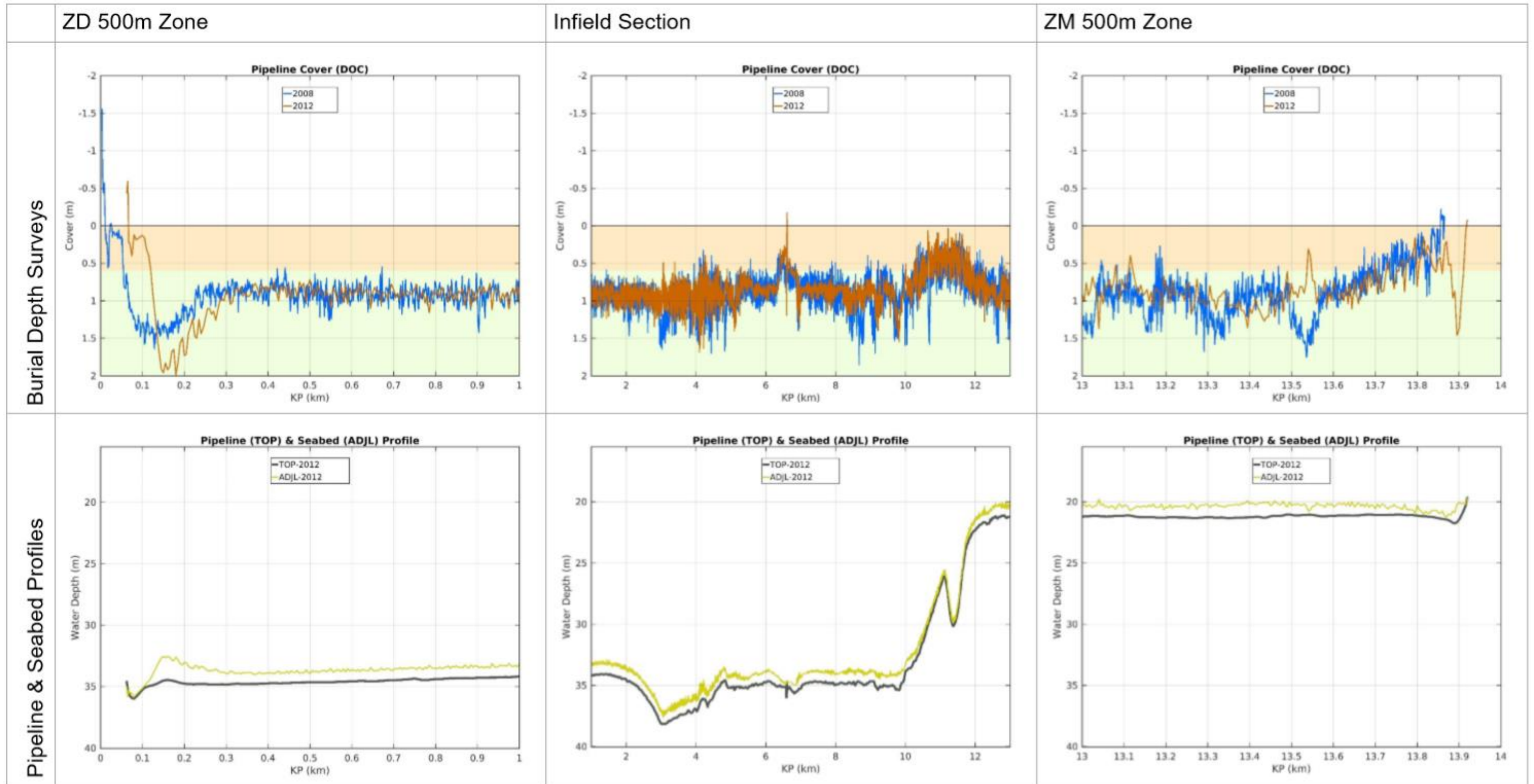

Note: ADJL = Adjacent seabed level at interface with pipeline (if pipeline buried or suspended then seabed level immediately above of beneath pipe respectively), DOC = Depth of Cover, TOP = Top of Pipe (depth to 12 o'clock position on the pipeline)

Pipeline depth of cover, top of pipe and seabed profiles

10 Appendix 2 – Public Notices



THE GAZETTE

OFFICIAL PUBLIC RECORD

Notice details

Type:

Planning

> Pipe-Lines

Publication date:

29 January 2020, 12:00

Edition:

The London Gazette

Notice ID:

3478682

Notice code:

1608

Pipe-Lines

CHRYSAOR PRODUCTION (U.K.) LIMITED

PUBLIC NOTICE

THE PETROLEUM ACT 1998

**LOGGS SATELLITES JUPITER AREA - GANYMEDE ZD, EUROPA
EZ, CALLISTO ZM, NW BELL ZX AND ASSOCIATED INFIELD
PIPELINES DECOMMISSIONING PROGRAMMES**

Chrysaor Production (U.K.) Limited has submitted, for the consideration of the Secretary of State for Business, Energy & Industrial Strategy, the draft Decommissioning Programmes for the Ganymede ZD and Europa EZ satellites, subsea tiebacks Calisto ZM and NW Bell ZX and their associated infield pipelines, in accordance with the provisions of the Petroleum Act 1998. It is a requirement of the Act that interested parties be consulted on such decommissioning proposals.

The items/facilities covered by the Decommissioning Programmes are:

The Ganymede ZD infrastructure lies 73 km east of the UK Lincolnshire coast in Block 49/22a, the Europa EZ infrastructure lies 67 km east of the Lincolnshire coast in Blocks 49/22a, 49/22c and 49/22d, the subsea tiebacks Callisto ZM and NW Bell ZX lie 73 km east of the UK Lincolnshire coast in Block 49/22a. The facilities include two infield satellite platforms, each comprising a topside and a jacket structure, two subsurface installations and one subsea tee and 10 infield pipelines (4 gas, 4 piggy-backed methanol and 2 umbilicals) and associated subsea stabilisation features.

Chrysaor Production (U.K.) Limited hereby gives notice that a summary of the LOGGS Satellites Jupiter Area - Ganymede ZD, Europa EZ, Callisto ZM, NW Bell ZX and Associated Infield Pipelines Decommissioning Programmes can be viewed at this address: www.chrysaor.com.

Alternatively, a hard copy of the programmes can be inspected at the following location during office hours:

Chrysaor Production (U.K.) Limited

Rubislaw House

Anderson Drive

Aberdeen AB15 6FZ

Contact: Michael Burnett, Decommissioning Strategy and Integration Manager

Representations regarding the LOGGS Satellites Jupiter Area - Ganymede ZD, Europa EZ, Callisto ZM, NW Bell ZX and Associated Infield Pipelines Decommissioning Programmes should be submitted in writing to the person named at the above address by the consultation closing date of 28 February 2020. Submissions should state the grounds upon which any representations are being made.

Date: 29 January 2020

PUBLIC NOTICE

The Petroleum Act 1998

LOGGS Satellites Jupiter Area - Ganymede ZD, Europa EZ, Callisto ZM, NW Bell ZX and Associated Infield Pipelines Decommissioning Programmes

Chrysaor Production (U.K.) Limited has submitted, for the consideration of the Secretary of State for Business, Energy & Industrial Strategy, the draft Decommissioning Programmes for the Ganymede ZD and Europa EZ satellites, subsea tiebacks Callisto ZM and NW Bell ZX and their associated infield pipelines, in accordance with the provisions of the Petroleum Act 1998. It is a requirement of the Act that interested parties be consulted on such decommissioning proposals.

The items/facilities covered by the Decommissioning Programmes are:

The Ganymede ZD infrastructure lies 73 km east of the UK Lincolnshire coast in Block 49/22a, the Europa EZ infrastructure lies 67 km east of the Lincolnshire coast in Blocks 49/22a, 49/22c and 49/22d, the subsea tiebacks Callisto ZM and NW Bell ZX lie 73 km east of the UK Lincolnshire coast in Block 49/22a. The facilities include two infield satellite platforms, each comprising a topside and a jacket structure, two subsurface installations and one subsea tee and 10 infield pipelines (4 gas, 4 piggy-backed methanol and 2 umbilicals) and associated subsea stabilisation features.

Chrysaor Production (U.K.) Limited hereby gives notice that a summary of the LOGGS Satellites Jupiter Area - Ganymede ZD, Europa EZ, Callisto ZM, NW Bell ZX and Associated Infield Pipelines Decommissioning Programmes can be viewed at this address: www.chrysaor.com.

Alternatively, a hard copy of the programmes can be inspected at the following location during office hours:

**Chrysaor Production (U.K.) Limited
Rubislaw House
Anderson Drive
Aberdeen AB15 6FZ**

Contact: Michael Burnett

Representations regarding the LOGGS Satellites Jupiter Area - Ganymede ZD, Europa EZ, Callisto ZM, NW Bell ZX and Associated Infield Pipelines Decommissioning Programmes should be submitted in writing to the person named at the above address by the consultation closing date of 28 February 2020. Submissions should state the grounds upon which any representations are being made.

Date: 29 January 2020

**Chrysaor Production (U.K.) Limited
Rubislaw House
Anderson Drive
Aberdeen AB15 6FZ**

**Michael Burnett
Decommissioning
Strategy and
Integration Manager**

The Petroleum Act 1998

LOGGS Satellites Jupiter Area - Ganymede ZD, Europa EZ, Callisto ZM, NW Bell ZX and Associated Infield Pipelines Decommissioning Programmes

Chrysaor Production (U.K.) Limited has submitted, for the consideration of the Secretary of State for Business, Energy & Industrial Strategy, the draft Decommissioning Programmes for the Ganymede ZD and Europa EZ satellites, subsea tiebacks Callisto ZM and NW Bell ZX and their associated infield pipelines, in accordance with the provisions of the Petroleum Act 1998. It is a requirement of the Act that interested parties be consulted on such decommissioning proposals.

The items/facilities covered by the Decommissioning Programmes are:

The Ganymede ZD infrastructure lies 73 km east of the UK Lincolnshire coast in Block 49/22a, the Europa EZ infrastructure lies 67 km east of the Lincolnshire coast in Blocks 49/22a, 49/22c and 49/22d, the subsea tiebacks Callisto ZM and NW Bell ZX lie 73 km east of the UK Lincolnshire coast in Block 49/22a. The facilities include two infield satellite platforms, each comprising a topside and a jacket structure, two subsurface installations and one subsea tee and 10 infield pipelines (4 gas, 4 piggy-backed methanol and 2 umbilicals) and associated subsea stabilisation features.

Chrysaor Production (U.K.) Limited hereby gives notice that a summary of the LOGGS Satellites Jupiter Area - Ganymede ZD, Europa EZ, Callisto ZM, NW Bell ZX and Associated Infield Pipelines Decommissioning Programmes can be viewed at this address: www.chrysaor.com.

Alternatively, a hard copy of the programmes can be inspected at the following location during office hours:

Chrysaor Production (U.K.) Limited
Rubislaw House
Anderson Drive
Aberdeen AB15 6FZ

Contact: Michael Burnett

Representations regarding the LOGGS Satellites Jupiter Area - Ganymede ZD, Europa EZ, Callisto ZM, NW Bell ZX and Associated Infield Pipelines Decommissioning Programmes should be submitted in writing to the person named at the above address by the consultation closing date of 28 February 2020. Submissions should state the grounds upon which any representations are being made.

Date: 29 January 2020

Chrysaor Production (U.K.) Limited Michael Burnett
Rubislaw House, Anderson Drive Decommissioning Strategy and
Aberdeen Integration Manager
AB15 6FZ

11 Appendix 3 – Consultee Responses

NFFO Services Ltd



30 Monkgate
York
YO31 7PF
Tel:01904 635 432
29th March 2020.

Michael Burnett
Decommissioning Strategy and Integration Manager
Chrysaor Production (UK) Ltd
Rubislaw House
Anderson Drive
Aberdeen
AB15 6FZ

Dear Michael

In reference to the decommissioning program for the Loggs Jupiter decommissioning program and associated infield pipelines.

The National Federation Fisherman's Organisation would like to thank Chrysaor for the detailed documentation explaining the planned methodology on planned decommissioning of these assets

The Federation would advise Over trawl surveys where possible, should be carried out to ascertain that the areas are free of snagging hazards post decommissioning.

NFFO Services department look forward to working closely with Chrysaor throughout the decommissioning process.

Kind Regards

Ian Rowe

Ian Rowe (General Manager)

NFFO Services Ltd